

Road tunnel civil engineering inspection guide

*Book 1: from disorder to analysis,
from analysis to rating*

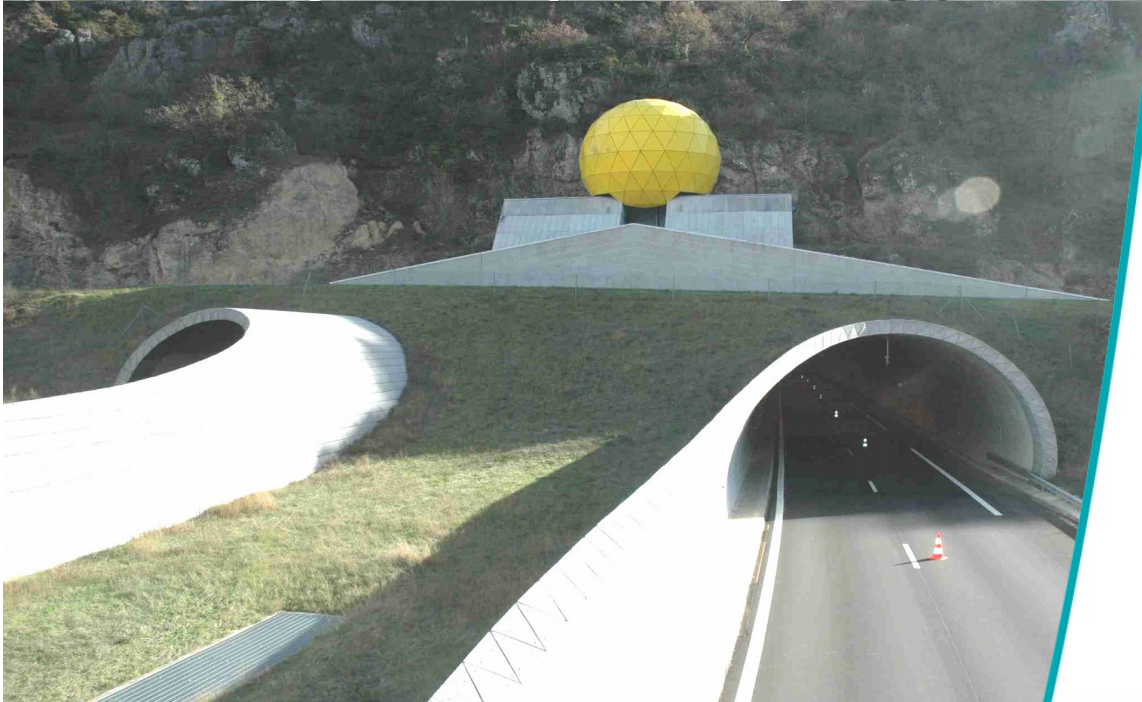
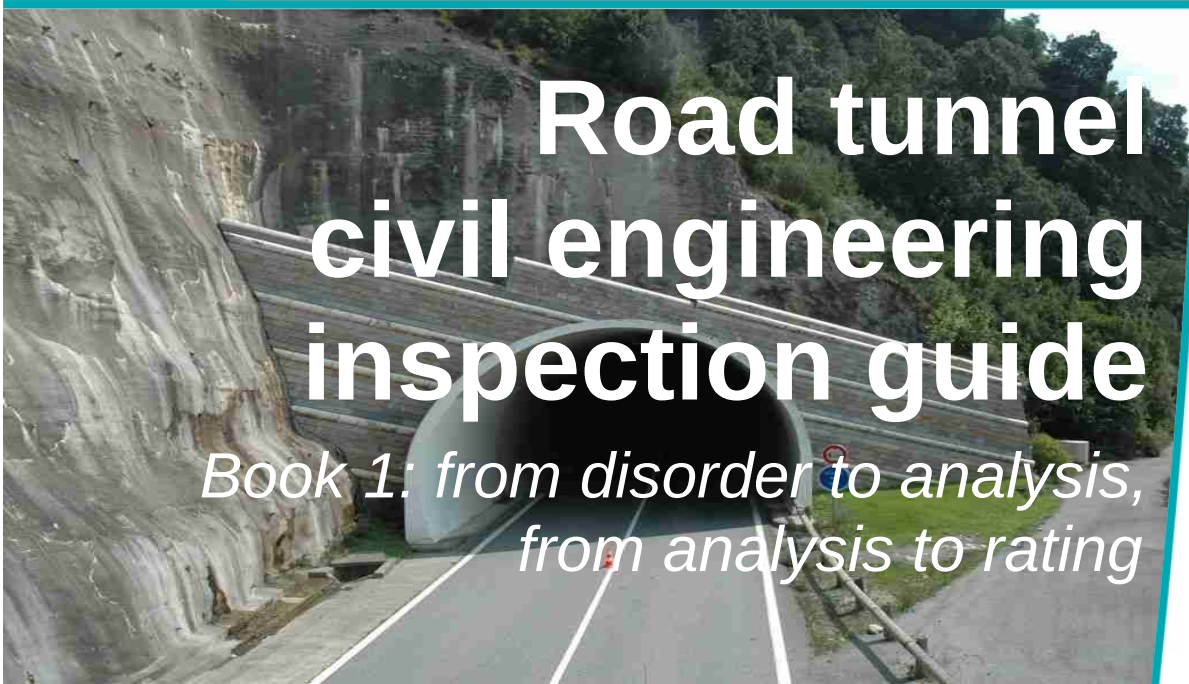

DISCLAIMER

This guide is the result of a process of synthesis, methodological assessment, research and feedback, either carried out or commissioned by CETU. It is designed to be used as a reference for the design, construction and operation of underground structures. As the guide takes stock of the state of the art at a particular time, the information it contains may become outdated, either due to developments in technology or regulations, or to developments of more efficient methods.

Road tunnel civil engineering inspection guide

*Book 1: from disorder to analysis,
from analysis to rating*

January 2015

Centre d'Études des Tunnels
25, avenue François Mitterrand
Case no. 1
69674 BRON - FRANCE
Tel.: 33 (0)4 72 14 34 00 – Fax: 33 (0)4 72 14 34 30
cetu@developpement-durable.gouv.fr
www.cetu.developpement-durable.gouv.fr

TABLE OF CONTENTS

1 FOREWORD	9
2 GENERAL POINTS	11
2.1 Scope.....	11
2.2 Content.....	11
2.3 Why should bored tunnels be inspected?.....	11
2.4 The regulatory context.....	12
2.5 Structural monitoring.....	12
2.6 Enhanced monitoring and intense surveillance.....	14
2.6.1 Enhanced monitoring	14
2.6.2 Intense surveillance	14
2.7 Parties involved.....	14
2.7.1 The Maître d'ouvrage constructeur (client or owner)	14
2.7.2 The Maître d'ouvrage gestionnaire (tunnel manager)	14
2.7.3 The inspection team	15
2.8 Safety conditions.....	16
3 DEFINITIONS	17
3.1 What is a tunnel?.....	17
3.2 Specific features of road tunnels.....	17
3.3 The various elements that comprise a tunnel.....	17
3.3.1 The portals	17
3.3.2 Ancilliary structures	19
3.3.3 The tunnel interior	20
4 DETERIORATIONS	27
4.1 INTRODUCTION.....	27
4.2 Terminology.....	28
4.2.1 Definitions proposed for inspections	28
4.2.2 Terms linked to water penetration	29
4.3 Catalogue of deteriorations.....	30
4.3.1 List of deteriorations	30
4.3.2 Model deterioration sheet	32
5 FACTORS BEHIND THE DETERIORATIONS	33
5.1 Factors related to the geological, geotechnical and hydrogeological conditions.....	33
5.1.1 Geological and geotechnical characteristics of the surrounding rock mass	34
5.1.2 Hydrogeological characteristics	35
5.1.3 Environmental causes	36
5.2 Factors linked to construction.....	36
5.2.1 Design	37
5.2.2 Creation Construction methods	37
5.2.3 Nature of the materials	38

5.3 Factors linked to the life of the structure.....	39
5.3.1 Chemical actions	39
5.3.2 Traffic	40
5.3.3 Monitoring and maintenance	41
5.4 Summary table.....	42
6 ANALYSIS OF DETERIORATIONS.....	44
6.1 Preliminary diagnosis.....	44
6.2 Identification of deteriorations and their development.....	44
6.3 Final diagnosis.....	45
6.4 Schematic diagrams for analysing deteriorations.....	46
6.4.1 Case with unlined excavations	46
6.4.2 Case with lined excavations	48
6.5 Example of an analysis of deteriorations, diagnosis and repairs.....	52
6.5.1 Description of the structure	52
6.5.2 Investigations and survey	53
6.5.3 Diagnosis	54
6.5.4 Rehabilitation project	54
6.5.5 Works	54
6.5.6 Conclusion	54
7 HOW TO CONDUCT A DETAILED INSPECTION.....	55
7.1 How to prepare for the inspection.....	55
7.1.1 Scheduling	55
7.1.2 Study of existing documents	55
7.1.3 Preparatory work	55
7.2 How to conduct the inspection.....	56
7.2.1 The resources, the tools	56
7.2.2 The inspection method	60
7.2.3 Office work	61
8 IQOA EVALUATION.....	63
8.1 Assessment principle.....	63
8.2 Dividing.....	63
8.2.1 Bores	63
8.2.2 Sections	63
8.2.3 Areas	64
8.2.4 Parts and sub-parts for the civil engineering works	64
8.2.5 Parts and sub-parts for water	65
8.3 Rating principles.....	66
8.3.1 State classes for an area	66
8.3.2 Summary table of IQOA scores	68
8.3.3 "Civil engineering" rating	68
8.3.4 "Water" rating	69
8.3.5 First aggregation of the IQOA scores by constituent part	69
8.3.6 Second aggregation and summary of ratings	69

9 BIBLIOGRAPHY.....	71
9.1 Instructions.....	71
9.2 Guides and recommendations.....	71
9.3 Internet sites.....	72
10 APPENDICES.....	73
10.1 Appendix 1: Logic diagram of the organisation of the monitoring of the civil engineering works of tunnels	74
10.2 Appendix 2: Intervention methods – Elements of a model specific technical clauses for a detailed inspection (DI) of a tunnel.....	75
10.2.1 Preliminary work to be carried out by the managing contracting party	75
10.2.2 Inspection team	75
10.2.3 Preparing the intervention	75
10.2.4 In-situ intervention	76
10.2.5 Assessment meeting	76
10.2.6 Creating surveys of the deteriorations	76
10.2.7 Drafting of the detailed inspection report	77
10.2.8 Conclusion meeting	77
10.2.9 Example of application to a bored tunnel with a concrete lining	77
10.3 Appendix 3: Safety conditions to be complied with during scheduled monitoring and maintenance actions – Specific difficulties for intervention.....	87
10.3.1 Foreword	87
10.3.2 Risks of accidents in the workplace – Regulations	87
10.3.3 Special provisions – Safety measures	87
10.3.4 Typical prevention plan	89
10.3.5 Risks and means for preventing them	90
10.4 Appendix 4: Characteristic transverse profiles over time.....	91
10.5 Appendix 5: Operation of a tunnel lining.....	95
10.5.1 Specifics with tunnel linings	95
10.5.2 Situations that generate deteriorations	95
10.5.3 Measurements	96
10.6 Appendix 6: Analysis and characterisations of materials.....	97
10.6.1 Analysis of water	97
10.6.2 Analysis of the composition of mortars and concrete	98
10.6.3 Tests on concrete	98
10.6.4 Other in situ tests	98
10.7 Appendix 7: Investigative techniques and additional tests.....	99
10.7.1 Crack measuring (1)	99
10.7.2 Convergence measurements (1, 2, 3)	99
10.7.3 Levelling (1, 2, 3)	100
10.7.4 Measuring the deformation of the lining via extensometry (1)	100
10.7.5 Profilometry via total station or continuously (1, 2, 3)	101
10.7.6 Geophysical radar (2, 3)	101
10.7.7 Scanning with visible light continuous laser (1, 2, 3)	102
10.7.8 Scanning with continuous laser thermography (1, 2, 3)	103
10.7.9 Analyses of mortars and concrete (2, 3)	103
10.7.10 Analyses of water (2, 3)	103
10.7.11 Pressure measurements (1, 2, 3)	103
10.7.12 Intrusive or core drilling (2, 3)	103
10.7.13 Windows (2, 3)	103
10.7.14 Trenches (2, 3)	104
10.7.15 Mechanical tests on samples (2, 3)	104
10.7.16 Stress measurements (2, 3)	104

10.7.17 Other survey techniques	104
10.8 Appendix 8: Principle of sectioning.....	105
10.8.1 Tubes	105
10.8.2 Sections	105
10.8.3 Development of the summary document	105
10.8.4 Sectioning – Example	106
10.9 Appendix 9: Marking of a tunnel.....	107
10.9.1 Purpose of marking	107
10.9.2 Origin of the marking	107
10.9.3 Permanency of the marking	107
10.9.4 Nature of the plates	108
10.9.5 Fastening the plates	108
10.10 Appendix 10: Frame for annual inspection report.....	109
10.11 Appendix 11: Design and codification of the intrados surveys.....	110
10.11.1 Report of observations	110
10.11.2 The form of the intrados surveys	110
10.11.3 Conventions, symbols and figures used in intrados surveys	111
10.12 Appendix 12: Model for detailed inspection report (DI).....	119
10.13 Appendix 13: Example of an IQOA rating for a tunnel.....	123
10.13.1 Stage 1: Establishing the sectioning – Example	124
10.13.2 Stage 2: Distribution of the sections – Example	125
10.13.3 Stage 3: Detailed inspection (see chapter 6)	125
10.13.4 Stage 4 (optional): Summary of the deteriorations – Example	126
10.13.5 Stage 5: Rating of the sub-parts and of the parts – First and second aggregation of the IQOA scores	127
10.13.6 Stage 6: Summary of the IQOA scores	128
10.14 Appendix 14: Nature and rating of the deteriorations – Area of influence.....	129
10.15 Appendix 15: Nature and rating of the deteriorations – Civil engineering equipment.....	130

1 FOREWORD

This guide is intended primarily for people in charge of conducting detailed civil engineering inspections of bored road tunnels. It is also intended for contracting authorities who manage these structures and who, in varying degrees, participate in organising and making use of monitoring activity.

This structured guide is used as a reference for inspecting tunnels of the national road network not under private management (NRN-NPM) but it can also be used by any other tunnel owners including: concession holders, local authorities, public bodies...

For this purpose, Book 1 provides the recommendations for establishing procedures for observing, analysing and classifying deteriorations that appear on the various parts of a tunnel. It also defines inspection as the basic tool for an effective monitoring policy for the structures.

Book 2, comprising the second part of this guide, includes in the form of a catalogue, all the deteriorations that can be observed in structures and as such allows inspectors to have practical guidance.

This guide was developed and published by the Centre d'études des tunnels (CETU) for which one of the objectives since 1974 has been the inspection of tunnels on the (French) national road network not under private management. The many files studied provide a great wealth of data through the variety of the road tunnels (in terms of the type of ground passed through, the types of lining, the age and the state of conservation of the structures) and through the diversity of the deteriorations that are described and photographed therein. They allow the document to draw on many practical examples. It is the sharing of experience accumulated since the first tunnel inspections that makes this guide important.

2 GENERAL POINTS

2.1 Scope

In terms of the (French) highway code, a tunnel is defined as any road or carriageway located under a covering structure which, regardless of the method of construction, creates a confined space. A road or carriageway section located under a covering structure is not a confined space when the covering structure includes openings to the outside of which the surface area is greater than or equal to one square metre per traffic lane per metre of carriageway.

The scope of this guide is limited to the civil engineering of bored tunnels and excludes cut-and-cover tunnels, for which the inspection and rating methods are covered in guides published by the "Service d'études sur les transports, les routes et leurs aménagements" (SETRA).

2.2 Content

This guide places the inspections in context, recommends the levels of qualification required for the personnel comprising the inspection team and indicates the equipment and resources necessary to undertake the inspections competently.

It then defines the various structural elements that form a tunnel as well as the terms specific to the structure and to the road that it covers. It provides definitions, as precisely as possible, of the most common deteriorations that can be found in tunnels, whether lined with masonry, concrete or unlined. This terminology is essential in order to perfect the training of inspectors and make it possible to describe, with a common vocabulary, the many "particularities" that can be encountered in structures.

This guide also presents elements for analysing the deteriorations detected during inspection. With the identification of a particular problem and its extent, it provides assistance for assessing the condition of the structure of the tunnel in a zone that the inspector defines using observations on site and from the study of "as-built" documents for the structure. The inspector can therefore establish a priority amongst the deteriorations, in terms of their severity, and recommend monitoring, maintenance or repair actions to be implemented.

By undertaking an inspection from a position close to the structure of the tunnel, the inspection method developed in this guide is visual and by hammer testing. This non-destructive method allows for a good evaluation of the condition of structures but does not prevent the inspector from asking for the implementation of other analysis methods to help him assess the "state of health" of all or a portion of the structure. It must however be kept in mind that all of these means supplement but do not replace the inspection.

Finally, the guide proposes a rating method "Image Qualité des Ouvrages d'Art" (IQOA) for tunnels. Its purpose is to provide two indicators, one concerning the state of the civil engineering and the other concerning the presence of water, which makes it possible to classify zones. This rating method is part of the periodic assessment process of the condition of engineering works set by the (French) "Instruction technique sur la surveillance et l'entretien des ouvrages" (ITSEOA).

The catalogue of deteriorations, which forms Book 2 of this guide, is presented in Chapter 4. Logically, as older structures have many more deteriorations, there is more data concerning their defects.

2.3 Why should bored tunnels be inspected?

Road tunnels are built to allow the passage of vehicle traffic in good conditions of safety and comfort. Yet, as with any engineering works, they are subject to ageing and changes that can put their stability, their functionality, the safety of the users or the level of service provided, in danger.

According to the age of the tunnel (and therefore the methods used at the time of construction, but also the changes that have occurred since that time), the deteriorations observed are different.

The common point with all tunnels is the fact that their behaviour is directly influenced by that of the ground in which they were constructed, as the rock formation is really an integral part of the structure and often

imposes the frequency and the intensity of the changes. Inflows of water are also the cause of many deteriorations and hinder operations.

Changes are almost always foreseeable over a time scale of a few years. The forecast is based partly on a general knowledge of problems and deterioration mechanisms that can be encountered and, partly, on the periodic detailed inspection of structures.

2.4 The regulatory context

ITSEOA specifies the obligations of tunnel managers in terms of monitoring, maintenance and repair.

The new ITSEOA of December 2010, which replaced the one published in October 1979 and modified in December 1995, is comprised of Volume 0 "General arrangements applicable to all structures" and three application documents:

- ◆ Document 1: Engineering works document
- ◆ Document 2: General points on monitoring
- ◆ Document 3: deformation monitoring, intrusive investigation, reinforced monitoring, intense surveillance, immediate safety or safeguarding measures.

The other documents that formed the second part of the 1979 ITSEOA, include Document 40 "Tunnels – Tranchées couvertes – Galeries de protection", are no longer a part of the ITSEOA and have now become technical guides.

The new document 40 "Tunnels – Génie civil et équipements" published in October 2012 presents the particular measures for monitoring and maintaining bored tunnels, cut-and-cover tunnels and similar road structures. Whilst intended for contractors in charge of operating, maintaining and managing the national public road network, it can also be used as a reference by any contractor in charge of privately managed structures. It covers two areas: civil engineering and operating and safety equipment. It contains sections covering:

- ◆ inspection, maintenance and monitoring of the civil engineering works (causes and nature of the deteriorations, data collection methods and survey methods),
- ◆ maintaining and inspecting safety and operating equipment,
- ◆ repair work.

The guide provides details of the method for carrying out initial or periodic civil engineering inspections for bored tunnels and for using their results. Chapter 8 provides details of the "Image Qualité des Ouvrages d'Art" (IQOA) assessment process that is applied to tunnels through a rating of the state of the civil engineering and of the presence of water. This guide supplements the information in document 40.

The condition and the performance of the safety and operating equipment are also rated using a method that is close to the IQOA procedure adopted for structures. Its principle is addressed in document 40 and details are provided in its appendices which are accessible on the "Centre d'études des tunnels" (CETU) website (www.cetu.developpement-durable.gouv.fr).

2.5 Structural monitoring

Monitoring a civil engineering structure includes all the controls and inspections that reveal its condition and any changes from a reference state. Some monitoring is continuous, some is periodic and some is one-off, linked to particular events in the life of the structure:

Continuous monitoring requires the ongoing recording of defects and abnormal events.

Periodic monitoring includes:

- ◆ annual inspections,
- ◆ assessment visits,
- ◆ periodic detailed inspections (PDI),
- ◆ detailed inspections of parts of structures.

One-off actions include:

- ◆ initial detailed inspections (IDI),
- ◆ specific inspections at the end of contractual guarantees,
- ◆ actions linked to unforeseen events.

The initial detailed inspection defines a reference state against which the other monitoring actions can be used to assess how it changes. This inspection takes place:

- ◆ at the end of the construction of the actual structure, possibly before the installation of safety and operating equipment;
- ◆ after major repair work or substantial modification of the structure;
- ◆ when the management of a structure is taken over by a new contractor, if the data files for the structure do not contain a recent examination report.

The periodic detailed inspection gives the current "state of health" of the complete structure. This is a visual inspection supplemented by hammer testing that can, where applicable, be supplemented further with surveys and measurements. It is possible to go further with the inspection by using non-destructive testing (sonic or ultrasonic measurements, infrared thermography, radar measurements...) or destructive testing (core drilling, window sampling...). Its content depends on the nature, the extent and the state of the structure, but all parts of the structure must be examined.

This inspection is normally conducted every six years. However, the tunnel owner can, if justified, deviate from this rule by extending the frequency to nine years for robust structures or, on the contrary, reduce it to three, two or even one year for structures that are particularly vulnerable or that have significant deteriorations. Appendix 1 shows a logic diagram for the organisation of the monitoring of a tunnel. This logic diagram also includes specific detailed inspections or visits provided for in document 40 and which correspond to events in the life of the structures for which details are provided below.

Certain portions of major structures cannot be examined using "traditional" methods of inspection. They therefore undergo a specific detailed inspection which can be conducted either during a periodic detailed inspection, or at another time. If the continuous surveillance and the annual inspections do not detect any defects, these parts can be examined at one inspection out of two.

Before the end of the maintenance period following construction, the structure or the parts of the structure involved, undergo a specific inspection, the purpose of which is to check their condition. These inspections must be carried out sufficiently well in advance of the expiry of the periods in order to be covered by contractual guarantees if necessary. A similar inspection should be carried out at the end of a term maintenance contract.

The logical diagram presented in appendix 1 provides for these; because of different deadlines due to various guarantees (on the structures, on the civil engineering equipment...) that can be applied during a tunnel construction contract, no fixed timescale can be set. Those authorities who build and manage tunnels are therefore invited to examine the various guarantees that concern their structures, and ensure the relevant inspections are conducted at the appropriate times.

Following special circumstances that are likely to have damaged a structure or when a serious defect has been detected, an exceptional detailed inspection, which can cover either one or several parts of the structure, must be organised.

2.6 Enhanced monitoring and intense surveillance

The particulars for “Surveillance renforcée et haute surveillance” are specified in the ITSEOA application booklet (Document 3).

2.6.1 Enhanced monitoring

When the state of the structure warrants it or in the event of uncertainty as to the origin, the nature or the cause of defects or when the structure is of an innovative or unusual nature, the tunnel manager can decide to subject it to enhanced monitoring, which is more intense than the previous monitoring regime.

Two cases must be distinguished:

- ◆ unique structures or those of an innovative nature which when constructed incorporated specific instrumentation intended for future monitoring: in this case, as the structure is already subject to a high level of monitoring; the results of the inspections may permit the monitoring regime to be downgraded to traditional detailed inspections;
- ◆ structures for which there are concerns over changes in the defects observed: in this case, the tunnel manager can define and undertake an enhanced monitoring regime for that structure.

2.6.2 Intense surveillance

When the deteriorations observed on a structure can jeopardise the safety or the serviceability of the structure, the tunnel manager can decide to place it under intense surveillance. This makes it possible, in the event of imminent danger, for the competent authorities to immediately take the necessary actions to ensure the safety of the structure.

Intense surveillance applies solely to a structure in a defective state. This is an exceptional measure which consists of looking out for signs indicating the possibility of a failure in the very near future in order to immediately take the pre-defined measures that are required for safety.

Placing a structure under intense surveillance is accompanied by an evaluation of the structure's residual strength in order to determine the relevant alarm thresholds which have to be defined as part of this procedure.

2.7 Parties involved

In accordance with French practice and ITSEOA, the various parties involved in an inspection visit and their role are defined below.

2.7.1 The Maître d'ouvrage constructeur (client or owner)

With new tunnels, the client or owner has the initiative in deciding when to undertake the initial detailed inspection (IDI), with the participation of the future tunnel manager. Whenever possible; the IDI is conducted before commissioning.

2.7.2 The Maître d'ouvrage gestionnaire (tunnel manager)

Defined in the ITSEOA document covering the measures that apply to all structures (document 0), the responsibilities of the tunnel manager include three levels, the strategic level, the organisational level and the operational level.

The strategic level

This covers the strategic planning and delivery of tunnel management services. It sets out the management policy for its asset management works, which leads it to:

- ◆ apply the policy defined in the ITSEOA, taking into account the constraints linked to operations with priority given to the safety of people;
- ◆ set and deliver the objectives through the provision of the appropriate human and financial resources commensurate with the value and the extent of the works;
- ◆ setting priorities for maintenance and repair activity based on an analysis that takes account of technical priorities, good planning, operating constraints, and disturbance to the user;
- ◆ ensure that they are implemented by setting up effective controls.

It does not take part in organising and undertaking the inspection.

The organisational level

The organisational level prepares a schedule for inspections and a frequency for intervention as well as prioritising the work based on the importance of the structure. It assists in preparing for the inspection by making the documents required for the intervention available to the inspection team and by supplying, where needed, support for a particular intervention.

It can organise, at the end of each visit to the site, a meeting with the inspection team for a preliminary assessment of the condition of the structure or the part of the structure being inspected.

It makes use of the various reports linked to the inspections (internal reports or reports from specialists). It analyses the structural deteriorations and any equipment defects to assess their severity and to identify any urgent maintenance actions or technical actions required to ensure safety.

In complex cases, it gathers recommendations from specialists and may commission additional investigations.

The operational level

The purpose of the operational level is to intervene on structures to carry out or manage the monitoring, maintenance or repair operations. It also covers measures relating to the monitoring process (traffic restriction, temporary signs, opening of access lanes, stopping ventilation, access to galleries or ventilation ducts, etc.) to facilitate the process and to ensure the safety of personnel.

It carries out the annual inspections, organises or performs routine maintenance and reports on its actions. It can also monitor certain operations concerning specialised maintenance.

It provides for continuous monitoring, by preparing and maintaining a permanent record of events to form an ongoing history of the civil engineering works.

After one-off events which have the potential to damage structures (impacts, earthquakes, etc.), it can undertake or have undertaken specific visits or inspections.

For all interventions undertaken in the field there must be a dated written record. These observations must be taken into account later when it comes to prescribing specific actions. A summary of these interventions and monitoring operations is fed back to the organisational level.

2.7.3 The inspection team

In France, detailed inspections of tunnels on the national road network and not under private management are conducted by the Centre d'Etudes des Tunnels (CETU). On an exceptional basis, they can be conducted by design consultancies specialising in tunnel condition assessment.

For tunnels not on the national road network or not under private management, detailed inspections can be conducted by an organisation which is part of the company managing the tunnel, if it has the necessary skills, or by specialised design consultancies. In this case, the design consultancy should be selected by enquiries based on specific specifications. Appendix 2 has an example of model technical clauses (CCTP) specifically for conducting a periodic detailed inspection.

The technical proposals from the design consultancies must list the qualifications and the previous relevant experience of the candidates for this type of work as well as the equipment that will be used.

In accordance with the ITSEOA, the detailed inspection must be directed and undertaken by someone of professional engineering status. That person is also responsible for drafting a report as well for the analyses and any conclusions it contains.

The inspection must be conducted by adequately qualified technicians who have relevant civil engineering experience. In addition, those persons must have received specific training on tunnel inspection. In France, the following minimum experience and qualifications are recommended:

- ◆ for an inspector or assistant:
 - ◆ one year's experience in the inspection of civil engineering structures and relevant technical knowledge;
- ◆ for an inspector or person in charge of studies:
 - ◆ holder of a level IV equivalent degree¹ (baccalaureate certificate, etc.): three years of experience in the inspection of civil engineering structures along with relevant knowledge of geotechnical engineering and the deterioration mechanisms associated with civil engineering structures.
 - ◆ holder of a level III degree (BTS (vocational training certificate), DUT (university technology degree, etc.) in civil engineering: one year of experience as well as knowledge of geotechnical engineering and deterioration mechanisms associated with civil engineering structures;
- ◆ for the manager of the on-site inspection team:
 - ◆ holder of a level III degree (BTS (vocational training certificate), DUT (university technology degree, etc.) in civil engineering: three years of experience in inspection as well as knowledge of geotechnical engineering and deterioration mechanisms associated with civil engineering structures;
 - ◆ holder of an engineering degree in civil engineering: one year of experience in inspection as well as knowledge of geotechnical engineering and deterioration mechanisms associated with civil engineering structures;
- ◆ for the inspection manager:
 - ◆ holder of an engineering degree in civil engineering: one year of experience in inspection as well as knowledge of geotechnical engineering and deterioration mechanisms associated with civil engineering structures.

The inspection team can, in addition, include personnel undergoing on-the-job training under the supervision of experienced personnel. These trainees should acquire a good knowledge of the behaviour of structures and, through their site experience, a good understanding of how structures deteriorate (visual appearance, cause, possible changes etc). Once trained, these people should be able to detect major defects and understand how to assess and analyse the information which has been collected.

2.8 Safety conditions

General health and safety requirements along with specific safety measures for tunnel inspections are listed in Appendix 3. Some of these requirements can be structure specific and should be identified as necessary by the operational and organisational levels of the tunnel management.

The wearing of personal protective equipment (PPE) is always mandatory. The usual minimum standards of equipment (coveralls and/or high visibility vest, safety shoes, gloves) should be supplemented with eye protection during the removal of loose materials, hearing protection is also required where traffic is still running. A helmet with chinstrap and a safety harness are required for access platform work.

Detailed inspections often require the use of a mobile elevating work platform (or aerial basket). In France, these devices must undergo periodic general verification (every 6 months) by an approved inspection body.

Persons operating these devices must hold specific personal authorisation (operating permit) provided by their employer. In addition to the user or users of the aerial basket, one person must be present to guide the aerial basket during delicate manoeuvres and to secure its working environment.

¹The reference nomenclature is that of the training levels of the national statistical commission on professional training and social promotion from March 1969

3 DEFINITIONS

3.1 What is a tunnel?

According to the new document 40, a tunnel is a confined space created by a covering structure, regardless of the method of construction. This is a broader definition compared to that of previous versions of the document in which the definition of a tunnel was restricted solely to bored structures.

From an asset manager's perspective, the tunnel includes all the ancillary structures (ventilation stations, building, etc.) as well as the underground structure. It is therefore important, for complex tunnels, to precisely identify the various structures as the detailed inspection of them may require different specialisms.

3.2 Specific features of road tunnels

A *tunnel* is comprised of one or several *bores* each containing one or several traffic lanes. The ends of each bore are called *portals*. The tunnel can also contain *cross-passages*.

Road tunnels contain features intended to facilitate safe operation, the protection and evacuation of the users in the event of an accident or fire, as well as the intervention of rescue services.

For tunnels that do not exceed 300 m in length, there are at least *safety recesses*.

For longer tunnels, *refuges*, *evacuation tunnels* or *service tunnels* or galleries are created.

According to the type of ventilation adopted, some tunnels are provided with *fresh air ducts* and *smoke extraction ducts*. These ducts can be located under the carriageway or above the lanes and separated from the traffic by a *roof slab* (or *false ceiling*).

All of these structures fall within the scope of detailed inspections.

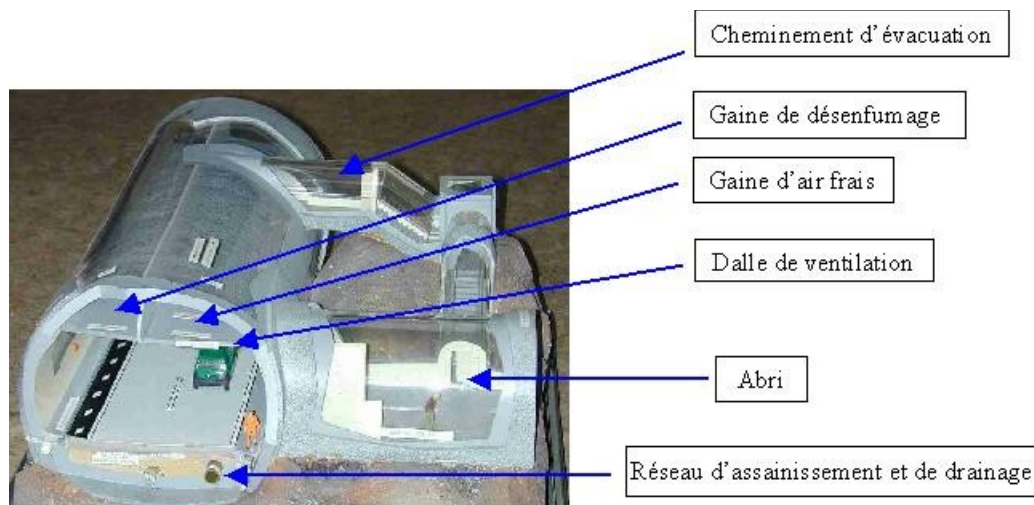

Figure 1: exploded view of the composition of a structure

3.3 The various elements that comprise a tunnel

3.3.1 The portals

This term has two meanings:

- ◆ spatial: it designates the entry or exit points to the underground structure;
- ◆ structural: it also refers to the specific structures that can be built at the ends of the bored tube.

"Natural" portal

In many old tunnels, the point of entry is directly into the rock face. Although the rock face has been altered to a greater or lesser extent during driving, there is no additional rock support at the entrance. These areas, which are often poorly defined geometrically, can present dangers for the users.



Figure 2: natural portal

"False" portal

In order to minimise the dangers posed by natural portals, additional structural support is often provided the entrance, to stabilise the rock face and to protect users from the risk of falling rock. Its length beyond the face into the open air can vary greatly, from a simple diaphragm wall built hard against the rock to a false portal extending several metres beyond the face and formed by wing walls.

The ground slope above the portal can be clad (masonry, concrete) or left as is. The same applies to any rock faces which dominate the entrance. These must be examined to the greatest extent possible within the limits of access available to the inspector.

Otherwise, the tunnel management can opt to employ a specialised company.



Figure 3: false portal

Portal structure

This is an actual extension of the tunnel, formed in the open air for a length of several metres. The structure can be different to that of the tunnel. The portal structure satisfies safety constraints, but also aerodynamic, aesthetic, and surface development constraints in an urban environment. When the structure is backfilled, this is referred to as a cut and cover structure.



Figure 4: architectural portal structure

3.3.2 Ancillary structures

Ancillary structures include the ventilation stations, structures above the portals or other types of structures that often extend tunnels of great length and act as a "portal". These can also include ventilation shafts, parallel bores (technical galleries, evacuation galleries, etc.), and certain intermediate ventilation stations built from the surface to the level of the tunnel.

These structures are highly diverse and while they fall within the scope of detailed inspections, have to be inspected by specialist service providers (e.g. experts in buildings, specialists in rope access work), other than the design consultancies or organisations that are competent in tunnel inspection.



Figure 5: ventilation plant at the tunnel portal

3.3.3 The tunnel interior

The term refers to the length of tunnel of typical cross-section. "Atypical zones" exist with particular features, such as *turnaround galleries, garages, recesses, shelters*, etc.

Limits of the interior zone

For bored tunnels, often the positions of the working faces are noted precisely in the "as built" records however they normally refer to site metric points (MP) the marking of which has often disappeared once the structure is finished.

This loss of information can cause deteriorations for example when referring afterwards to the geological profile of the structure to correlate the as built information with the deteriorations observed.

In the absence of more precise data, the ends of the last rings that are fully embedded underground are considered to form the limits of the interior zone of the tunnel.

The boundaries between the interior zone and the various structures that can extend the tunnel (overlying structures, false portals, smoke recirculation prevention walls, local technical buildings, etc.) are always marked with joints that can often be identified.

Slope or ramp

These terms define the inclination (as a percentage) along the tunnel. In France, "Slope" is used to designate a descending profile, "ramp" for an ascending profile, in the direction of increasing points of reference (PR) or metric points (MP).

Crossfall

The crossfall is the transverse inclination of the carriageway in the tunnel. It is expressed as a percentage.

In tunnels, whether they are uni-directional or bi-directional and if the geometrical characteristics allow, the crossfall direction should be consistent throughout the tunnel as this makes it possible to install the drainage system on just one side. Consequently the need to run pipes under the carriageway to accommodate changes in the side drained is avoided.

Overbreak / under excavation etc

During excavation work, overbreak is the volume of surrounding ground excavated beyond the excavation line (or theoretical profile) planned. Overbreak can be due to poor control of the blasting or to lower ground strength.

On the other hand, under excavation is a volume of ground remaining, after excavation, within the planned limit of excavation. Encroachment is the term applied to a section of lining which would be inside the intrados profile.

Unlined section

This is a section of bored tunnel left with the natural rock surface exposed. This can extend over the entire tunnel or just one or several sections. Some sections can be reinforced locally by bolting.



Figure 7: Unlined tunnel

Lined section

A section of tunnel which is partially or totally supported by an internal lining, installed in intimate contact with the ground. It is possible to have a lined section in which the lining is not in close contact with the ground and in which the annular space can sometimes be accessed. Appendix 4 shows a few illustrations of characteristic transverse profiles of lined sections of tunnels.



Figure 8: un-reinforced concrete lining

Clearance gauge

The clearance gauge is the maximum static height of a vehicle, including the load, for which passage can be accepted, under normal traffic conditions, in the structure. This height is a characteristic of the vehicle.

The authorised clearance gauge (G) (or permissible clearance gauge) corresponds to the maximum clearance gauge of the structure. It corresponds to the height indicated on road signs outside the tunnel (in France “panneau B12”) as well as in the “règlement de circulation” for that road. The authorised clearance

gauge must be less than or equal to the minimum free height of the structure (H), less an allowance for dynamic effects (Md) along with a safety (Mp) margin, and rounded down to the next lower multiple of 10 cm.

The minimum free height (H) (or air draught) is defined as the minimum distance between any point on the carriageway and a corresponding point on the underside of the crown of the structure or of any equipment that it supports. In measuring the free height, equipment linked to compliance with the height limitation such as a protective bar above the carriageway is not taken into account).

The protective margin (Mp) makes it possible to provide protection for equipment. CETU recommends that this protective margin has a value of 10cm.

The dynamic margin (Md) takes account of the dynamic movements of vehicles in traffic. This margin, which is a regulatory requirement, must be at least equal to 20 or 30cm.

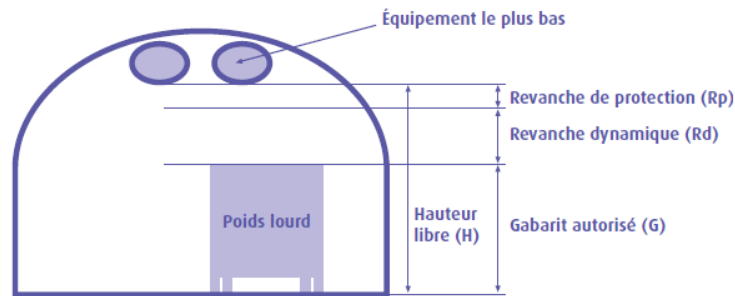

Figure 9: illustration of the various heights to be taken into account in determining the clearance gauge of a tunnel

Type of road	Authorised clearance gauge (G)	Minimum free height (H) without equipment	Minimum free height (H) with equipment
General case	4.10 m	4.30 m	4.40 m
International road	4.30 m	4.50 m	4.60 m
Motorway	4.50 m	4.75 m	4.85 m

Figure 10: height of road structures



Figure 11: Type B12 sign indicating the authorised clearance gauge

Intrados

This term denotes the surface comprised by the lower surface of the tunnel crown, the invert, and the internal surface of the sidewalls. It is therefore the inner visible surface of the tunnel.

For unlined tunnels, the intrados corresponds to the "excavated surface".

Extrados

The extrados is defined as the convex outer surface of the tunnel lining, in contact with the surrounding ground.

For a traditional lining in an arched tunnel, it is invisible. It can sometimes be accessed for self-supporting structures (shells, double arches).

Arch

The arch is the visible curved portion of the lining located above the carriageway. It is comprised of sidewalls, haunches (or springers) and the roof section. The key is the highest point of the arch.

Roof section

The roof section or roof is the upper and central portion of the arch. It can have various shapes: semi-circular (round), elliptical or flat. The portion of the arch between the roof section and the upper portion of the sidewalls is called the springer (or haunch). It is located between the start of the curved section of roof and the top of the sidewalls.

Sidewall

Sidewalls are the lateral parts of the tunnel cross-section, located between the haunches and the carriageway (or the walkways) of the structure. Sidewalls can be straight and vertical, or slightly concave.

Invert

Sometimes an invert or base slab is formed in the lower part of a tunnel between the two sidewalls in order to provide rigidity to the lining when passing through poor-quality ground or to satisfy a requirement for watertightness. It is not visible once the carriageway has been installed.

The invert or base slab, when there is one, can be formed from a flat slab (flat raft) or an inverted concrete arch (counter-arched raft). Deteriorations with the invert cannot be observed directly once the tunnel is in use, but can be inferred from deteriorations or defects induced in nearby structures or in the carriageway.

In documents concerning the construction of the structure, the creation of a temporary base slab may be mentioned. This is a platform, most often made of concrete, that is required for the passage of vehicles during the construction phase. This raft has no structural role and can be demolished after the final carriageways have been created.

Counter-arch

See invert

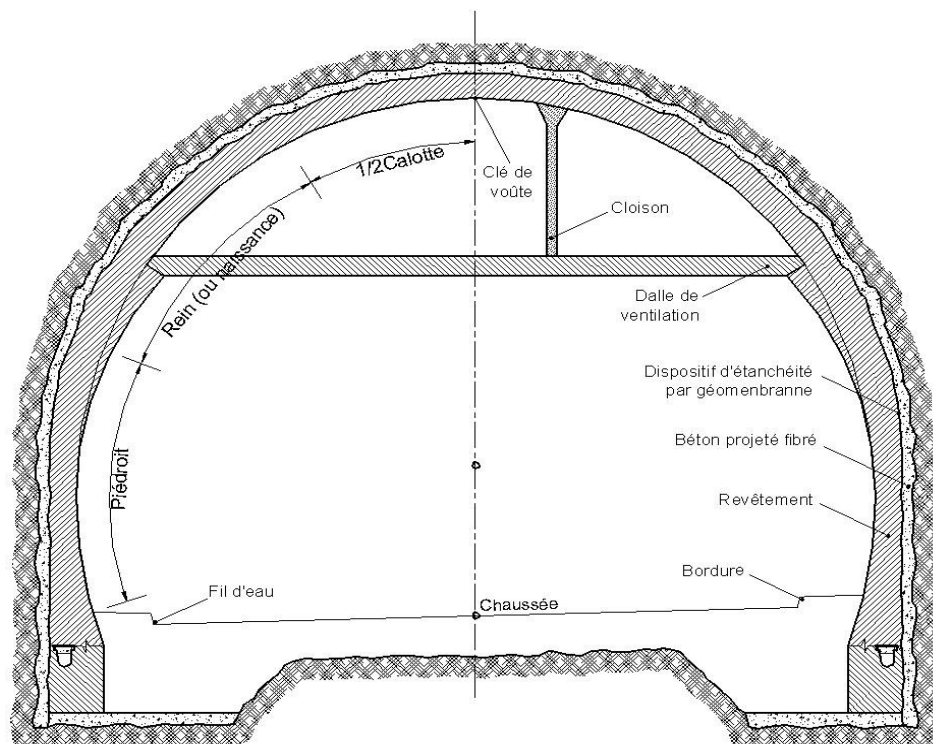

Figure 12: breakdown of a tunnel traverse profile

Lining

This can consist of brick, masonry or stone rubble, sprayed concrete, cast or prefabricated concrete.

In the case of old "wrought stone" tunnels (stone laid on mortar), the stonework can be either structural (lining) or non-structural (cladding).

Segments are curved prefabricated elements, which when assembled form the circular lining of a tunnel that is generally bored using a tunnel boring machine. They can be made of reinforced concrete, steel, cast iron or ductile iron. Keystones allow for the closure of the ring of lining and provide continuity of support through compression of the other segments against the ground. Despite their name, they are not necessarily located at the highest point of the arch.

Non-structural cladding or panels

Corrugated iron and other cladding (metal sheets, composite or prefabricated concrete materials etc) are not lining in the strict sense of the term as they are not an integral part of the tunnel's structure.

The same applies to passive protection against fire, installed on the arches or the underside of a suspended ventilation duct.

Different types of cladding can normally be distinguished by the way they are fastened to the structure.

Waterproofing

Waterproofing is installed to prevent ground water from coming into contact with the lining (geomembrane seals in new tunnels) and from creating deteriorations or from reaching the traffic zone. It is always associated with a specific drainage feature (extrados channels or drains), that is permanently concealed by the lining.

Draining the lining

These are the means for collecting and removing any ground water collected at the base of the waterproofing membrane (the case with geomembrane seals) or which passes through the lining (in tunnels without waterproofing on the extrados) and which can degrade the structure or adversely affect the operation of it. For draining water that has already passed through the lining, the drains are normally installed as remedial measures from inside the tunnel as such tunnels are already in operation. Water penetration deteriorations of this nature can be seen clearly.

Alternatively when there is an impermeable seal on the extrados, drainage is supplemented by inspection chambers, often located in recesses.

Pavement

This is the term for all of the layers of material that are placed on the base slab (natural or man-made). The pavement can be reduced to a single layer concrete slab such as for carriageways supported by invert-level ventilation ducts. The support points for these slabs can be the source of special deteriorations.

Pavement drainage

This is drainage installed in the pavement or incorporated into the base slab to collect and remove ground water inflow from the pavement.

Failure of the drainage system can induce deteriorations in the carriageway. Pavement drainage systems can only be inspected by using a remote camera or via individual inspection chambers.

Surface water drainage

These are the drains installed on the hard shoulders or in walkway areas to collect and remove surface water from the carriageway. These are either slotted drainage channels or walkway drainage channels that convey the water to the pavement drains.

In tunnels over 300 m long, slotted drains are connected to collection chambers that incorporate a "fire-break" system.

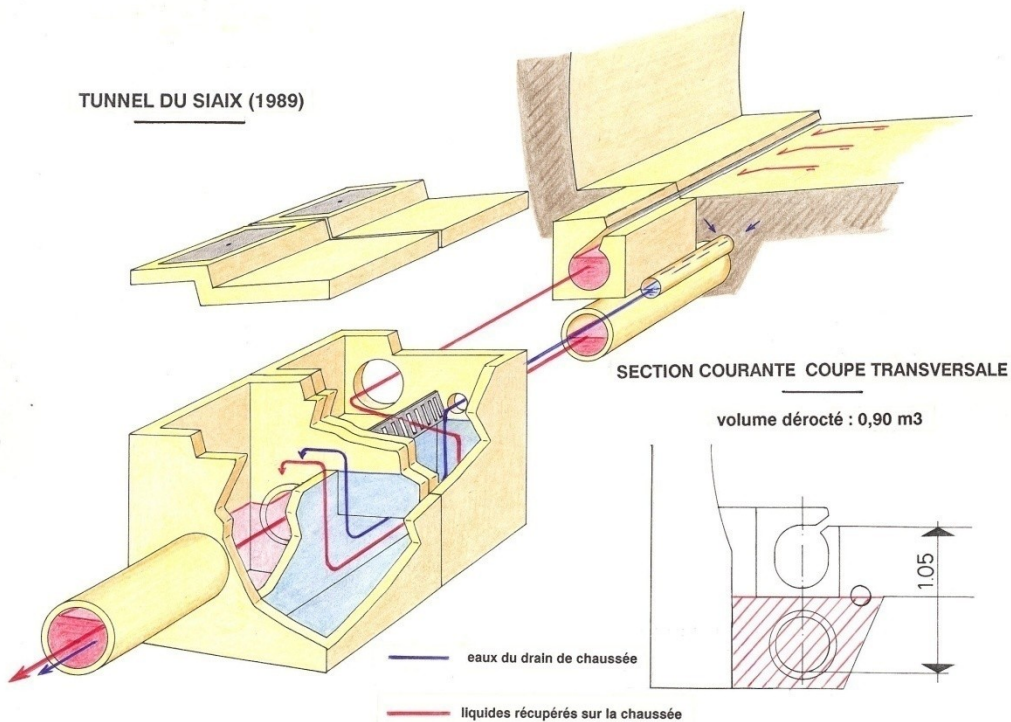

Figure 13: siphon trap

A malfunction with the collection chamber induce deteriorations on the carriageway and alter the "fire-break" operation of the chamber. Pipework can only be inspected by using a remote camera or via individual inspection chambers.

Civil engineering equipment (finishing work)

These elements, located within tunnel profile, have no structural role. They are comprised of:

- ◆ slabs (or ceiling) and their support points,
- ◆ partition walls between ducts,
- ◆ slab hangers,
- ◆ carriageway joints (slab supporting a carriageway),
- ◆ the slab support system (slab supporting a carriageway or ventilation slab).

These parts of structures are generally accessible and often form voids for ventilation, operational or safety purposes.

4 DETERIORATIONS

The deteriorations or faults that are most often observed during tunnel inspection, have been grouped together and classified by theme in the form of a separate catalogue that forms Book 2 of this guide. Inspectors thus have practical detail sheets that they can use. This is also an information tool for managers on specific civil engineering issues and on the presence of water in tunnels.

This chapter introduces the catalogue of deteriorations and defines a large number of terms that can be found in the sheets.

4.1 INTRODUCTION

New tunnels, new deteriorations

Civil engineering for tunnels is becoming increasingly complex. The current techniques make it possible to create structures that meet the stability requirements imposed for operation and safety reasons.

Civil engineering equipment (finishing work) such as false ceilings and the partition walls for ventilation ducts can have deteriorations or defects inherent in their the design, construction and method of operation.

In recent tunnels (since around 1980), the cast in situ concrete lining and the systematic installation of waterproofing have substantially reduced the problems of inflows of water, but other deteriorations have appeared, especially concerning watertightness and drainage.

The heritage from the past is always present

Renovating the most degraded older tunnels is tending to progressively remove the deteriorations and faults that were common in the past, however they remain on other tunnels. It is therefore important to keep them in mind.

For road tunnels, the catalogue extends the lists established in the "Guide de l'inspection du génie civil des tunnels routiers – Du désordre vers le diagnostic" published by CETU in 2004.

Know what to look for and how to look for it

Inspecting a structure is an approach that is primarily based on observation and description. The choice which therefore has to be made is to compare deteriorations and defects through their appearance rather than by focussing on the factors that trigger them.

Deteriorations, just like defects, can vary from the discrete to the spectacular, in terms of their visible manifestation as well as their extent. However their severity is not necessarily in proportion to their "visibility". Consequently, it is sometimes difficult to establish priorities, which is the first step towards diagnosing the problem before searching for a remedial treatment.

Understanding

If possible during the inspection, the origin of these deteriorations or defects must be searched for. Their severity and how they change depend on a variable combination of the following two types of causes:

- ◆ "internal" causes, linked to intrinsic characteristics of the lining materials (composition, porosity, texture, micro-cracking, etc.), which can be considered as "inherent weaknesses";
- ◆ "external" causes, linked to the surroundings, the behaviour of the surrounding ground or the functions of the structure, which can be qualified as "external factors" and which can be of a physical, chemical, functional nature, or any combinations of these. The influence of water is a contributory factor in a considerable number of these cases.

Unlike defects, the late appearance of deteriorations always requires going back to the design and the conditions during building the structure. It is therefore essential to consult the "as built" records prepared at the end of the tunnel construction period and supplemented over the life of the tunnel by the tunnel operator.

4.2 Terminology

Many terms are used in the technical literature when referring to "anomalies" (in the broad sense of the term) that affect structures. They are not all standardised and some of them are duplicated. They often reflect the culture of each trade.

A few simple definitions that can be applied to tunnel inspection are provided below.

4.2.1 Definitions proposed for inspections

Fault or poor workmanship

A fault (or poor workmanship) is the result of a task that has manifestly been poorly executed or specifications that were not followed. This is an imperfection, whether visible or invisible, one-off or systematic, that affects a portion of the structure. It generally doesn't have any consequences, but it can be part of a problem, provoke one, or aggravate one.

Most of the faults encountered in tunnels do not affect safety or the life span of the structure.

Examples:

- ◆ faults in the appearance of the cladding,
- ◆ alignment fault in masonry or lips between segments during construction,
- ◆ a deformation in formwork, which may be reproduced in each ring cast,
- ◆ imperfections in alignment in old unlined tunnels which arose during construction,
- ◆ honeycombing, segregation, blowholes, bleeding or loss of fines in concrete.

Deterioration

The term "deterioration" is used to refer to any problem that affects an element or a part of the structure and which manifests itself gradually or suddenly and which denotes a change; it is a symptom. It is different from a fault, which is a one-off or systematic imperfection, most often arising from construction. It is also referred to as "damage", more particularly so by the French Railway company SNCF.

The causes of deteriorations are multiple. In addition to an unfavourable change in faults or poor workmanship, the main causes of deteriorations are the alteration of materials and structures, the behaviour of the surrounding ground and the action of water.

During an inspection of the structure, it is important to search as early as possible for the probable causes of the deterioration observed.

Examples:

- ◆ appearance of cracks, deformation,
- ◆ alteration of mortar, rubble, scaling, cracks,
- ◆ appearance of or changes in water inflow.

Deteriorations change in different ways and the terms below illustrate this:

- ◆ former problem: repairs which have suppressed the cause of the problem although traces of it are still visible (for example, rebuilt masonry but the deformation is still apparent);
- ◆ "dormant" problem: the problem exists and could be reactivated by some change in local conditions (for example, renewed slipping at a portal, swelling linked to hydration of clays, etc.);
- ◆ "active" problem: the problem exists and the current conditions prevent it becoming dormant. Active deteriorations can be ongoing:
 - ◆ continuously (chemical alteration, for example),
 - ◆ periodic (deformation, cracks, scaling, for example),
 - ◆ in cycles (for example, deteriorations linked to seasonal temperature differences in the lining), without necessarily becoming serious over time.

Behaviour with time

The behaviour with time of a fault or problem can be defined as the sum of all recognised deteriorations, the factors that trigger them or maintain them and the likely changes with time.

Good knowledge of the long term behaviour makes it possible to direct the choice of repairs more effectively.

4.2.2 Terms linked to water penetration

Water and the materials that it conveys, which appear inside the structure, can be described using the following terms.

Damp

No flow can be seen. More or less extended wet zones are initiated at a crack, a joint or any other fault in the lining, including areas of high permeability. Damp is linked to the season or the temperature or ventilation regimes of the tunnel.

When searching for the causes, one must be circumspect as damp can sometimes be caused by a simple phenomenon such as condensation on the intrados.

Seepage

A slight flow on the surface can be seen, without being able to locate the source or sources. This problem is quantified by the surface area over which it occurs.

Inflow of water

A flow of water which can be seen emanating from an identifiable source. It is possible to estimate or even measure a flow rate. A distinction is made between discontinuous inflows of water (drop by drop) and continuous inflows of water (higher flow rate).

Ingress of water through pavement

An ingress of water through the pavement should be differentiated from damp coming from the arch, sidewalls or vehicles.

Surface deposits

The presence of water can result in the deposit of a range of minerals (on the intrados or on an open surface) also referred to as exudates. As these are evidence of internal chemical activity, they need to be well defined.

The term "concretion" is reserved for all solid deposits adhering to the lining: calcium carbonate (or calcite), calcium sulphate (or gypsum), iron hydroxide (or goethite). A "stalactite" is a concretion that forms around a point source generally located in the crown or haunch.

The term "efflorescence" is a specific term that applies to fragile and temporary deposits especially on mortars, that appear under certain conditions of atmospheric or substrate humidity. Its formation is directly linked to the presence of sulphates at the surface or within the substrate, Efflorescence can take the form of a dust or white powder (sodium sulphate).

The term "deposit", unlike the preceding terms, applies to all non-solid deposits adhering to a substrate and linked to a flow of water, which can appear or accumulate on an open surface. They can have the consistency of mud, a gel (iron products). In rare cases they arise from bacterial action.

In the case of drains or collector pipes, examined at their open ends or by means of a camera, efforts should be made to differentiate between concretions (solid products) and various accumulations (fines, sand, mud, etc.) or material build-up resulting from poorly executed work (loss of grout, fines, concrete, etc.). That drain is then referred to as a drain or collector pipe that is "clogged" or partially blocked by calcite. Both deteriorations can occur in the same length of pipe.

4.3 Catalogue of deteriorations

4.3.1 List of deteriorations

The catalogue of deteriorations comprises 47 sheets that describe the main deteriorations and defects observed in road tunnels and the ways to detect them, identify them and assess them. The sheets are grouped together and identified by family.

Deteriorations due to water	
Water ingress	HY-1
Concretions	HY-2
Effects of freezing	HY-3
Efflorescence on mortar and concrete	HY-4
Deteriorations due to the surrounding ground	
Karsts and cavities	ZI-1
Deteriorations at the portals	ZI-2
Slope instability	ZI-3
Deteriorations in unlined sections	
Loose rock masses or blocks	NR-1
Sagging beds or plates	NR-2
Deteriorations of lining materials Stone or brick masonry linings	
Honeycombing	RM-1
Flaking	RM-2
Exfoliation	RM-3
Spalling due to compressive load	RM-4
Deterioration of mortar – Voids in joints	RM-5
Deteriorations of lining materials Concrete lining (cast in situ or precast)	
Chipping	RB-1
Concrete deterioration – Swelling	RB-2
Spalling due to compressive load	RB-3
Spalling due to corrosion of reinforcement	RB-4
Sprayed concrete deteriorations	RB-5
Deteriorations in waterproofing, drainage and surface water collection systems	
Deteriorations in intrados drainage	ED-1
Deteriorations in extrados drains and culverts	ED-2
Deteriorations in roadway drains	ED-3
Deteriorations in extrados waterproof membranes	ED-4
Deteriorations in sheeting	ED-5
Deteriorations in waterproof tanking	ED-6
Deteriorations in thin mortar coatings	ED-7
Deteriorations in waterproof insulating panels	ED-8
Deteriorations in swellable waterstops	ED-9

Deteriorations affecting the structural elements and geometry of the tunnel	
Cracks	
Horizontal structural cracks	FI-1
Diagonal structural cracks	FI-2
Verticale structural cracks	FI-3
Shrinkage cracks	FI-4
Crescent-shaped cracks	FI-5
Deteriorations affecting the structural elements and geometry of the tunnel	
Deformations	
Flattened crown – Symmetrical squeezing – Asymmetrical squeezing	DF-1
Bulging	DF-2
Offset stone or brick courses	DF-3
Invert deterioration	DF-4
Arch rupture	DF-5
Deteriorations affecting the structural elements and geometry of the tunnel	
Defects linked to workmanship	
Unstable blast hole bottoms	MO-1
Voids in the lining near the intrados	MO-2
Honeycombing	MO-3
Deteriorations in concrete construction joints	MO-4
Cosmetic defects with cast concrete	MO-5
Deteriorations in civil engineering elements	
Deteriorations in carriageways	EQ-1
Deteriorations in slabs and partitions	EQ-2
Deteriorations associated with fire	
Deteriorations due to fire	IN-1
Deteriorations associated with poor maintenance	
Poor maintenance	EN-1

Only the most frequently encountered deteriorations or faults in road tunnels are covered on each sheet. For descriptions of less common deteriorations affecting water tunnels or railway structures, the inspector can refer to the "Catalogue des désordres en ouvrages souterrains" published by the French Association for Tunnels and Underground Spaces (Association Française des Tunnels et de l'Espace Souterrain (AFTES)) in 2005.

4.3.2 Model deterioration sheet

The sheets are grouped into families and each has the same format as shown on the next page.

Name of deterioration (<i>usual name</i>)	Type – No.
Description (visual appearance of the deterioration)	
<i>The manner in which deterioration manifests itself to the observer</i>	
Inspection methods	
<i>Manner to detect the deterioration if it is not visible.</i>	
Parameters to be measured	
<i>Material or measurable elements that are linked to it.</i>	
Associated deteriorations or defects to be looked for	
<i>Elements useful for the diagnosis.</i>	
Origins and possible causes	
<i>Interpretations made, based on knowledge of the structure.</i>	
Aggravating factors	
<i>Elements able to aggravate or accelerate a change in the problem.</i>	
Consequences, possible evolution	
<i>Description of changes in the problem in the absence of maintenance or repair work.</i>	
Dangers for the users	
<i>Immediate occurrence of incidents or accidents to which users can be subjected (where applicable, the red colour of the band indicates the possible existence of a danger linked to the presence of the problem).</i>	
Risks to the tunnel and its structural elements	
<i>Short or medium term occurrence of changes in the structures (the colour of the bands corresponds to that of the maximum IQOA rating that can be assigned to the problem).</i>	
Monitoring	
<i>Measures to be taken and observations to be made in the short or medium term.</i>	
Remedial measures	
<i>Basis for consideration of remedial treatment which can be applied to eliminate the problem or slow it down.</i>	
Observations	
<i>Elements linked to other deteriorations or which exhibit some of the previous points.</i>	
Additional information	
<i>Descriptions, photographs and diagrams that explain and illustrate the problem.</i>	

5 FACTORS BEHIND THE DETERIORATIONS

The purpose of a tunnel inspection is to identify the deteriorations that occur over time in order to establish a diagnosis of the structure's condition. Any noted deteriorations are therefore the consequences of a deterioration mechanism that may have various root causes:

- the geological, geotechnical and hydrogeological conditions of the rock mass surrounding the tunnel section may affect the extrados if a lining exists or directly affect the tunnel walls;
- the construction of the tunnel when defects in the design, use or even nature of the materials constituting the tunnel are proven;
- the ageing of materials caused by the various chemical attacks to which the structure is subjected.

The purpose of the diagnosis is therefore to identify the relative contribution of each of these factors. When a lining exists, only its intrados will show signs of deteriorations. Good knowledge of the construction of a lined section of tunnel and understanding how it functions are therefore essential: appendices 4 and 5 may provide useful reference regarding this matter.

5.1 Factors related to the geological, geotechnical and hydrogeological conditions

The life of a tunnel comprises two stages: a construction stage and an operating stage. The inspector is often involved during this second operating phase in order to determine how the structure is wearing over time. However, the information collected during the excavation phase is essential because it accurately conveys the ground conditions in which the tunnel is excavated. In the case of a lined tunnel, the geological, geotechnical and hydrogeological information is only available at the time of excavation.

When considering the geotechnical zone of influence, there are three main causes of deterioration which may occur either alone or together:

- geological and geotechnical: the nature and the characteristics of the ground that the tunnel passes through constitute vital data that have significant influence on the tunnel's behaviour. For example, a particular area encountered during excavation may have subsequent repercussions on the stability of the structures used depending on the treatments employed during the construction phase;
- hydrogeological: the hydrogeological characteristics of the rock mass play a major role in triggering or accelerating the ageing of structures;
- environmental: anthropogenic mechanisms in the vicinity of a tunnel may have repercussions on the interior zone of the structure or at its extremities. Moreover, biological, climatic and seismic mechanisms are catalysts for deteriorations.

The following chapter aims to explain the connection between the deterioration mechanisms noted in a tunnel environment and their causes that can be detected at the time of excavation.

Three cases can be distinguished:

- *unlined tunnels (or sections)*: deteriorations of geotechnical origin will be falling blocks due to deterioration of the mechanical properties of the joints or matrix caused by deterioration;
- *old lined tunnels*: numerous probing campaigns through masonry linings have shown the existence of fairly substantial voids. These voids were either originally present or created by the transportation of materials. As the lining's performance is optimum when it is in contact with the ground, any gaps can weaken it at that location, which could result in permanent damage. It should be noted that ground swelling produces the same effects if the stress exerted is not taken into account in the design of the lining;
- *modern lined tunnels*: current construction techniques aim to quickly confine the excavated ground by a support system. However, linings are designed to withstand all stresses without taking into account the support system.

5.1.1 Geological and geotechnical characteristics of the surrounding rock mass

Rock mass characteristics

A rock mass may be characterized by a brief description of its lithology, its degree of fracturing and the presence of singular zones. In the case of an unlined tunnel, this data can be observed directly. In the case of a lined tunnel, the geological documents relating to its study and construction constitute the only data available outside of additional investigations. Such investigations are rarely carried out.

- **Lithology**

Sedimentary formations can be distinguished from magmatic or metamorphic rock in the following fairly simplified way:

- sedimentary formations may often comprise alternating hard layers (limestone) and softer layers (or interbeds) (marls). In limestone formations, the form of old unlined excavations is often linked to the positioning of the most compact layers used as the "roof" to guarantee the stability of the tunnel. The final section of the tunnel may retain this structure with irregular forms;
- metamorphosed formations often have a significant degree of fracturing initially created by their foliation. This foliation forms a greater or lesser degree of lamination that can result in instability between layers;
- detrital and volcanic formations are, for example, old detrital (molasses, conglomerates) or volcano-detrital (pyroclastic breccia) accumulations that behave as a continuous medium. They are not significantly stratified or structured and can be sensitive to alteration.

- **Fracturing**

Irrespective of whether they are of stratigraphic or tectonic origin, the discontinuities present in the rock formation constitute planes of weakness that deteriorate its mechanical properties. It should be noted that further fracturing could be produced by the excavation methods applied. Orientation, spacing, persistence roughness, deterioration of the vein walls, aperture, filling and water seepage are the eight parameters that characterise discontinuities. These characteristics play a major role in the occurrence and development of instabilities. Instabilities are in the form of rock wedges or plates delimited by the discontinuities present in the rock mass.

- **Singular zones**

The tunnel may have crossed fault areas. These are singular zones characterised by more intense fracturing. The final stage of this fracturing is complete crushing (mylonite) or localised alteration (fault breccia) of the rock. Over time such rock may have become more or less re-cemented. Depending on the orientation of the fault in relation to the tunnel, instabilities can be generated over a substantial length.

Deteriorations due to rock formation changes

- **During excavation: stress relaxation**

Subjected to the weight of the formations and possible tectonic compressions, the rock formation is compressed. Excavation causes stress relaxation of the ground around the tunnel. Depending on the situation, this stress relaxation can either be left to take place or it is stopped to prevent possible surface settlement.

Normally, in the case of a tunnel in operation, it can be considered that the rock mass has found a new equilibrium and that the stress relaxation is not a factor of deteriorations, as opposed to alteration.

- **During the operation: alteration**

Alteration is almost entirely linked to the action of water (groundwater, humidity in the air). It tends to weaken the mechanical properties of the rock mass by changing the mineralogical characteristics of the rocks, joints and their filling. This is therefore a medium and long-term behaviour.

Sensitivity to alteration depends on the nature of the minerals, their texture and porosity. A few typical examples can be mentioned:

- evaporites (gypsum) that are sensitive to dissolving, leading to the formation of cavities;
- anhydrite (anhydrous calcium sulphate) that has a high potential for swelling;
- clay minerals (smectites for example) that have a high potential for swelling;
- alteration of the matrix of certain conglomerates in areas of poor cohesion, which results in the falling of blocks which may sometimes be considerable in size;
- alteration of sedimentary rocks with dissolving of the limestone part (for example, limestone cement molasses becoming sandy and crumbly) which results in the falling of blocks;
- deep alteration of the matrices of magmatic and metamorphic rocks with the formation of phyllite minerals (similar to clays) that are sensitive to water (swelling).

5.1.2 Hydrogeological characteristics

The presence of water in a rock mass

Water is potentially present in all rock masses since a portion of precipitations infiltrates into the soil. The level of water in the rock mass determines the hydraulic head and the water's ability to move in the rock mass is represented by its permeability. The typology of the permeability depends on the formations encountered:

- granular formations (sand and gravel types) where water circulates in the pores, or voids between the grains;
- fractured rocks (granite, gneiss, basalt, etc.) where water only circulates in the fractures;
- dual porosity formations, where water circulates in the fractures and in the porous (chalk, sandstone) or altered (arenized granite) matrix;
- karstic rocks (limestone, gypsum) where water circulates everywhere particularly in conduits with random dimensions and distributions;
- fault zones (singular zones), filled with crushed materials that often act as drains within the fractured rock masses.

The damaging effects of water for the tunnel

- **Alteration**

An increase in the water content of certain sensitive materials alters them and softens them, allowing them to be eroded.

- **Erosion, transport and deposit**

The mechanical action of water flow transports eroded particles (which can result in the loss of mortar from joints) and deposits them elsewhere (deposits of gravel under pockets of deteriorated concrete or sand at the base of the masonry). Voids are slowly created within such structures. Depending on the permeability, the water run-off can carry fines, which clog the drains and collector pipes.

- **Freezing**

In cold regions, freezing can have a harmful influence on structures (accumulations of ice), but also on the constituents of porous materials (masonry units, mortar, concrete). It is not the intensity of freezing that triggers frost weathering but the frequency of freeze/thaw cycles; on the other hand, it is the intensity and the duration of freezing which determines the depth of damage in the material. Systematically applying waterproofing membranes to the extrados in new tunnels reduces these deteriorations to some extent.

- **Hydrostatic pressure**

Water flow may seep into the tunnel itself (or come into contact with its lining) depending on the type of permeability of the rock mass. As most bored road tunnels are located above the water table, pressure on the lining is unusual, and most often of short duration, and does not affect the entire structure. It can occur in more permeable areas, open karsts or faults. In these cases, such pressure can lead to temporary significant water flow rates in poorly-drained structures (old tunnels) or in areas of defective waterproof membrane (recent tunnels).

Generally, as water is a major contributing factor to deteriorations, its origin must be determined (natural sources, leaks in distribution network), as well as its chemical composition and its flow rate (variable). Appendix 6 summarises the main analyses that can be conducted on water encountered in tunnels.

5.1.3 Environmental causes

Chemical and biochemical attacks

Micro-organisms are present throughout the ground and in soils. Certain bacteria have a harmful effect on structures:

- sulfo-oxidising bacteria (thiobacilli) detected in railway tunnels, sewers and certain monuments: they result in the breakdown of carbonate materials and also of pyrites, the result of which is the generation of a sulphate reaction;
- nitrifying bacteria, which produce nitrous and nitric acids and which also attack carbonates: these are present in crusts or surface concretions. They seem to play a role in the superficial delamination of masonry but also in "concrete corrosion" and the appearance of some gel-like deposits.

Generally, they seem to act as a catalyst for the reaction rather than the trigger of it, which can explain why no significant problem has been attributed to them to date in road tunnels.

In aggressive chemical environments (maritime environments for example), the corrosion of reinforcements may be significantly accelerated.

Influence of the climate

Variations in temperature, primarily at the portals but also in the interior zone, introduce expansion/contraction phenomena in the structures, down to the level of individual particles for some materials (mortars, masonry units, porous concrete), which sometimes accelerate their deterioration. It should be noted that some very long structures overcome temperature variations via their significant overburden.

Air movements can introduce rapid desiccation and consequently, transfer of water vapour along with migration of salts in the materials.

Seismicity

A region's seismicity is a factor to be considered, although to date no proven problem can be attributed to it in tunnels in France. It is considered that the tunnel structure formed by the support system and the lining is integral with the ground and consequently vibrates in harmony with the ground in the event of an earthquake, which generally supports its stability. However, in modern tunnels, civil engineering equipment, which is suspended or acts as support mechanism (ventilation slabs, partitions, double-deck carriageway), could react poorly to certain loads of seismic origin. Also, in old tunnels, linings that are deteriorated or poorly fastened to the ground may be more likely to damage in earthquakes.

5.2 Factors linked to construction

Although current research methods along with the developments in techniques and equipment make it possible to reduce the uncertainty in projects and their execution, faults linked to construction are still possible.

It is therefore essential that deteriorations which have required adaptations to methodology at the time of construction are not forgotten or excluded from (as being solved) the as-built documentation relating to the structure.

All the original faults identified as potentially detrimental to the structure must be identified and treated during the work phase.

In old tunnels, for which as built or periodic inspection records may have disappeared, the causes of the deteriorations observed can only be deduced from observation, from knowledge of similar cases, or even from investigation (analyses, windows, core drilling).

5.2.1 Design

Although certain very old tunnels are in good condition despite their age, many of them have defect histories that are clearly linked to poor local design of the structures. This can only be a retrospective judgement, deduced from prolonged observation of any abnormal behaviour of the structure.

Many old tunnels were built with only minimal investigation or with limited geotechnical knowledge. Design was based on feedback from previous structures. Linings were therefore not always designed to withstand long term ground behaviour, the importance of which was not appreciated then.

The deteriorations, sometimes serious, that came up during construction, were solved "as best as possible" with the means available. These ad-hoc adaptations have sometimes failed to resist the passing of time.

- ◆ *Example in an old tunnel: the construction of a masonry arch under a void resulting from a loss of ground led to the creation of protective timbering and the construction of the lining by means of very short advance lengths; the presence of voids behind the lining resulted, many years later, in rock instability in the void above the arch;*

Taking incorrect account of water has sometimes resulted in creating poorly-drained structures, with rapid local deterioration. More recently, modern structures, benefiting from more complex drainage systems, give rise to new deteriorations concerning maintenance, which are directly related to their design.

- ◆ *Example in a recent tunnel: the small-diameter drains located under the carriageway are not all maintainable and quickly fill with calcite, leading to unintentional loading on and water discharge at carriageway level; the only solution is to create a new drain;*

Finally, savings that were made at the design stage resulted in difficulties during operation or in problems in the structure.

- ◆ *Example in a recently built tunnel with a watertight lining: collecting water at the extrados was often carried out using PVC agricultural drain pipes; their lack of strength resulted in local crushing when the arch concrete was cast; this quickly resulted in discharge of water through the carriageway and utility ducts.*

5.2.2 Creation Construction methods

The influence of this factor can be applied to all types of tunnels and to all time periods.

Some problems, which have required complex intervention in old tunnels, demonstrate the major difficulties in construction encountered by companies who did not always know how to handle unforeseen deteriorations. These construction difficulties also explain the occasionally serious or repeatedly poor workmanship which is detected much later and associated with the deteriorations.

Discrepancies are frequently noted between the work carried out and the contract specifications, as well as non-compliance with the basic rules of construction, despite the supervisory controls that were in place .

Boring

Historic methods of rock breaking did not allow for perfect control of the profile of the excavations (low number of holes, manual boring, poorly-adapted charges). This resulted in a profile that was often very far from the theoretical profile.

Supporting structures

In the past, supporting structures consisted simply of temporary timbering allowing the lining to be built, sometimes a long time after rock excavation. This resulted in long term relaxation of ground stresses around the excavation, stress relaxation which is at the origin of some deteriorations that have appeared since then.

In modern tunnels, the immediate installation of a lining support structure prevents the widespread relaxation of ground stress around the excavation by providing a confinement pressure, which will substantially slow convergence (or decrease it in the section).

Linings

In the past, linings were often intended to simply contain a local change in the rock that was deemed as threatening the permanency of the structure or the safety of the users. This explains the presence, in certain tunnels, of many short rings alternating with unlined areas deemed as more stable.

In the case of masonry linings, the design required any void between the arch and the ground to be packed using ordinary masonry (coming from backfill) bound with mortar, or dry-stone. Examining many arch extrados (by soundings, observation windows formed in the lining or in some instances examining ruins) has shown that packing of the structure was sometimes neglected, especially at the roof section where the annular space was difficult to access above the formwork and was not or was only partly backfilled. The visible intrados often shows masonry joints of highly variable thicknesses, rubble with widely varying dimensions (without mentioning the quality). Poor workmanship can be mentioned here, as these techniques were already well mastered.

On the other hand, the oldest linings made of sprayed concrete show faults that were inherent in the techniques at the time, which had much poorer performance than today (inaccurate dosing, working with small quantities at a time, much re-working, lack of homogeneity).

In recent concrete lined tunnels, and despite high-performance tools, faults still occur such as voids above the key, material segregation, torn waterproof sheets, localised ring cracking and deformation. We can also speak of poor workmanship.

Controlling water

A tunnel is like a drain in a rock formation; the materials from which it is built are therefore subject to the natural flow of water. Such water can be permanent or temporary in nature, sometimes that water can be aggressive with regards to the materials.

In old structures, rendering with mortar or metal sheets installed on the extrados were the only forms of protection against inflows of water. Regardless of the quality of the construction, their lifespan was limited. The same goes for drainage, which consisted of discharge openings or drainage blankets.

More modern structures, on the contrary, have a wide range of sealing and draining systems (dating from the time of construction or later) which require specific installation techniques along with careful inspection and maintenance throughout the life of the structure.

5.2.3 Nature of the materials

This is at the origin of many deteriorations in old lined tunnels.

Masonry

The stone used to provide the masonry came, whenever possible, from the nearest quarries, which sometimes specifically were opened for that purpose. The mechanical quality and the resistance to alteration varie greatly. The stone was selected sometimes by exposing it to the open air for one year, thus allowing for the elimination of frost susceptible material or excessively degradable material.

Despite this, much cladding contains stone taken from the excavation backfill (disposal of spoil), although they should have been reserved for packing behind the lining blocking.

Bricks

When there was a lack of stone, lining were made with bricks if there was industrial manufacture for them nearby. Rather frequent firing defects resulted in a rapid alteration in certain series of bricks.

Solid concrete blocks

Used until the 1940's, these elements resisted alteration well, as they were pre-cast from a material that was richer in cement and less permeable than insitu concrete cast at that time. The consistency of shape and geometric regularity of their surfaces favours a good distribution of stress in the body of the arch.

Mortars

Binders have changed constantly over time, as well as the manufacturing standards for mortars and concrete. The advantage of mortars is their greater permeability than stone; as such, they play a protective role acting as a "sponge" in the masonry as they are the preferred path for the transfer of moisture and water vapour; on the contrary, this permeability makes them more sensitive to chemical attack which degrades them over time.

Concrete

Some old cast concrete has been entirely altered after just a few decades. The cause can be found in the solubility of the cementitious binders, in the use of unsuitable aggregates, which contain minerals prone to cause degradation of the binders (pyrite, sulphates), or in variability in batching and mixing the concrete for the structure. The cements used were sometimes very sensitive to aggressive water. The vibration of concrete, replacing tamping, was not really used until the 1950's.

In modern structures, deteriorations linked to the quality of the concrete are much less frequent.

Waterproofing

Waterproofing systems on the extrados were definitively required around 1985 and are still changing. They are currently called geomembrane seals.

Previously, the rare installation of impermeable sheets before concreting was intended solely for limiting the leaching of the concrete during the casting in areas of seepage.

The oldest arches were sometimes equipped, around the extrados of the roof section, with metal sheets coated with "coal tar"; these water diverting devices made it possible to slow down the alteration of the masonry for a certain period of time.

Corrugated iron installed against the intrados of very wet arches, is still used but, aims only to improve the conditions for traffic but does not protect the primary lining at all. They are rather susceptible to impact from vehicles and conceal any structural changes in the structure.

Drainage

For buried networks, a poor choice of drainage materials or products can favour the faster appearance of deteriorations (under-sized or fragile drains). An obvious lack of care during installation is often observed in new tunnels (pipes rupturing, site debris), which later gives rise to many maintenance problems.

5.3 Factors linked to the life of the structure

Whatever its nature, the lining is subjected to various aggressive chemicals as it ages.

In a tunnel in service, the traffic has an impact on the structure; its effects can be permanent, ongoing, accidental or exceptional. Deteriorations can be additive.

The operating procedures can make it possible to minimise the negative consequences of the traffic, especially if subject to regular monitoring and maintenance.

5.3.1 Chemical actions

Listed below are their main consequences for concrete and mortars.

Concrete is a highly alkaline material on which the outside environment has an acidic corrosive action, generally due to water action. Complex chemical reactions take place between the aggressive acidic chemicals and the hydrates in the cement paste. The high alkalinity of concrete does however provide it with a certain inherent protection against this type of attack.

Carbonation

This is a natural ageing phenomenon that is beneficial for non-reinforced concrete and detrimental for reinforced concrete. Concrete's high alkalinity protects the reinforcement against corrosion. As carbonation lowers the pH of the concrete, the reinforcement can rust and cause surface bursting. In this specific case, carbonation becomes a problem factor.

Sulphate reactions

Sulphates are widespread in the natural environment and are most deleterious for binders and concrete. The degradation comes from the formation of expansive minerals ("secondary" ettringite) which lead to the disintegration of mortars in particular, but also concrete.

Sulphates can be of external origin (surrounding ground, water) or internal origin (sulphates trapped in the constituent materials or excessive heating during installation).

Sulphates of external origin concern old tunnels which have not been properly waterproofed. The use of cements with the addition of ground granulated blastfurnace slag (GGBS) at least 60% or sulphate resistant cements allows for better resistance to sulphates.

Sulphates of internal origin can be considered a potential problem in very thick linings (>80cm) and in tunnels that have substantial profile irregularities.

The alkali reaction

This is an example of complex chemical reactions, in the concrete, between certain forms of silica or silicates, that can be present in the aggregates, and the alkalis of the concrete or the aggregate. Reaction products are formed (in the form of gel and/or crystalline material) that cause the expansion and cracking of the concrete mass, and even eruptions of reaction products at the open surface. The deleterious nature of these reactions is considerably increased by the presence of a large quantity of water.

Observed until now on structures exposed to the environment, it has not been encountered in road tunnels.

The action of chlorides

These are present in the marine environment, in brine from de-icing, and also in certain concrete additives. Free chlorides contribute directly and aggressively to the corrosion process affecting the reinforcement in concrete, initiated by carbonation, as well as in the progressive degradation of the concrete.

This type of aggression can be encountered in immersed tube tunnels in the sea.

5.3.2 Traffic

According to the extent of the traffic the effects induced are of several types.

Permanent effects

Even in the presence of adequate ventilation, air pollution and the carryover of salt as brine and other deicing materials in winter encourage the corrosion of equipment and the structures themselves, if the structure has poorly protected reinforcement. Vibration generated by the traffic on carriageway slabs resting on supports, causes fatigue and problems on the latter.

Note however that the pollution due to the traffic does not directly alter the concrete.

Common effects

Repeated impact damage from passing lorries can have detectable effects on old fragile linings.

Accidental effects

Whilst personal injury is of primary concern, vehicle impact can also result in fire or have a detrimental effect particularly on cladding such as corrugated iron

Exceptional events

In tunnels with a low point in their longitudinal profile flooding can occur simply by a build-up of water flow from outside the tunnel which the drainage pumps cannot remove.

Fires are also exceptional events and have highly variable consequences according to their extent and their duration. From a structural standpoint, they lead to a decrease in the mechanical properties of the materials, in the resistance of the structures and, depending on the concrete, possibly, to a variable degree of spalling.

5.3.3 Monitoring and maintenance

Regardless of the importance of the traffic route or the complexity of a structure, regular and formalised monitoring must be applied. Indeed, a tunnel is a confined space in which any incident can rapidly escalate to dangerous proportions in terms of safety.

This monitoring must apply to the structure as well as to the equipment and must allow for proper management of the routine maintenance operations which require, firstly:

- ◆ frequent cleaning of the carriageway and walkways,
- ◆ cleaning of the surface water drainage (water systems, culverts and collection chambers),
- ◆ cleaning of the parts of the drainage networks that can be accessed.

Specialised maintenance (such as high pressure water jetting of the surface water drainage system is generally entrusted to companies; it is triggered by the tunnel manager on a periodic basis and/or according to the findings of ongoing monitoring or inspection.

Unfortunately, the recommendations concerning continuous surveillance and routine maintenance are not always followed. Initially this results in a danger for the users, then in a degradation of certain parts of the structure which leads to the development of major deteriorations which could have been avoided or detected earlier.

5.4 Summary table

The following table compares the deteriorations, described in the sheets of the CETU's "Catalogue of deterioration", with the factors of influence mentioned in this chapter. It makes it possible to observe that most of the deteriorations can have several origins (noted +), with the possible dominant factor distinguished (noted ++).

List of deteriorations	Sheet no.	Factors of influence							
		Site			Construction			Life of the structure	
		rockSurrounding	Action of water	Environment	Design	Construction Methods	Nature of the materials	Operation	Monitoring Maintenance
Deteriorations due to water									
Water ingress	HY-1	++	++	+			+		
Concretions	HY-2	+	++	+					
Effects of freezing	HY-3		++	+			++		
Efflorescence on mortars and concrete	HY-4	+	++				+		
Deteriorations due to the surrounding ground									
Karsts and cavities	ZI-1	++	+						
Deteriorations at the portals	ZI-2	+	+	+		+			+
Slope instability	ZI-3	++	+						
Deteriorations in unlined sections									
Loose rock masses or blocks	NR-1	++	+	+		+			+
Sagging beds or plates	NR-2	++	+	+		+			+
Deteriorations of lining materials Stone or brick masonry linings									
Honeycombing	RM-1		+	+			++		
Flaking	RM-2		+	+			++		
Exfoliation	RM-3		+				++		
Spalling due to compressive load	RM-4	++				+	+		
Deterioration of mortars – Voids in joints	RM-5		++	+	+	+	++		
Deteriorations of lining materials Concrete linings (cast in situ or precast)									
Chipping	RB-1			+		+		++	
Concrete deterioration – Swelling	RB-2		++	+		+	+		
Spalling due to compressive load	RB-3	++				+			
Spalling due to corrosion of reinforcements	RB-4		++		+	+			
Sprayed concrete deteriorations	RB-5	+	+			+			
Deteriorations in waterproofing, drainage and surface water collection systems									
Deteriorations in intrados drainage	ED-1		+	+	+	++	+	+	++
Deteriorations in extrados drains and culverts	ED-2		+		+	++	+		+
Deteriorations in roadway drains	ED-3		+		+	++	+		+
Deteriorations in extrados waterproof membranes	ED-4					++			

List of deteriorations	Sheet no.	Factors of influence							
		Site			Construction			Life of the structure	
		rockSurrounding	Action of water	Environment	Design	Construction Methods	Nature of the materials	Operation	Monitoring Maintenance
Deteriorations in sheeting	ED-5		+			+	+	++	+
Deteriorations in waterproof tanking	ED-6		++	+	+	+	+		
Deteriorations in thin mortar coatings	ED-7		++	+	+	+	+		
Deteriorations in waterproof insulating panels	ED-8				+	+			
Deteriorations in swellable waterstops	ED-9		++			++	+		
Deteriorations affecting the structural elements and geometry of the tunnel									
Cracks									
Horizontal structural cracks	FI-1	++							
Diagonal structural cracks	FI-2	++							
Vertical structural cracks	FI-3	++							
Shrinkage cracks	FI-4					+	+		
Crescent-shaped cracks	FI-5					++			
Deteriorations affecting the structural elements and geometry of the tunnel									
Deformations									
Flattened crown – Symmetrical squeezing – Asymmetrical squeezing	DF-1	++			+	+	+		
Bulging	DF-2	+	+		+	++	++		
Offset stone or brick courses	DF-3					++			
Invert deterioration	DF-4	+	+		+	+		+	
Arch rupture	DF-5	+	+			+	+		
Deteriorations affecting the structural elements and geometry of the tunnel									
Defects linked to workmanship									
Unstable blast hole bottoms	MO-1	+				++			+
Voids in the lining near the intrados	MO-2					++	+		
Honeycombing	MO-3					++	+		
Deteriorations in concrete construction joints	MO-4				+	++			
Cosmetic defects with cast concrete	MO-5					++	+		
Deteriorations in civil engineering elements									
Deteriorations in carriageways	EQ-1	+	+			+	+	+	+
Deteriorations in slabs and partitions	EQ-2				+	+		+	
Deteriorations associated with fire									
Deteriorations due to fire	IN-1				+		+	+	+
Deteriorations associated with poor maintenance									
Poor maintenance	EN-1							+	++

6 ANALYSIS OF DETERIORATIONS

The analysis of the state of a structure or of one of its parts has to be able to answer the following four questions (according to AFTES recommendations):

- ◆ what are the causes of the deteriorations?
- ◆ how can the deteriorations change?
- ◆ what is the degree of urgency of the actions to be initiated?
- ◆ what investigations, studies or work need to be planned?

After the observation and the detection of deteriorations, the analysis leading to the diagnosis of the problem includes the following steps:

- ◆ the pre-diagnosis, which has to list the hypotheses for the causes of the deteriorations and provide preliminary answers;
- ◆ the identification of the deterioration and its development over time, which makes it possible to prioritise the consequences for the structure and for the users;
- ◆ the diagnosis itself, based on all of the investigatory work and studies and which leads to the identification of a suitable method of repair if necessary.

6.1 Preliminary diagnosis

The preliminary diagnosis is based on the knowledge derived from the complete study of all the documents available and on the observations undertaken of the structure. For simple cases, it can already answer the questions that the diagnosis will have to address. In more complex cases, additional investigations will be required in order to remove uncertainties.

The preliminary diagnosis must make it possible to detect "areas" in the tunnel. An area is a part of a structure having consistent structural characteristics and presenting problems of a similar degree of severity. "Sensitive" areas, i.e. areas for which the tunnel condition suggests the rapid appearance or aggravation of the deteriorations, can require enhanced monitoring (in ITSEOA terms) or additional investigations as mentioned above.

Dividing the tunnel into areas has the advantage, right from the preliminary diagnosis, of focussing the attention of the tunnel manager and inspection teams on the most sensitive areas of the tunnel.

6.2 Identification of deteriorations and their development

Tunnel deteriorations rarely stem from just one cause but very often stem from a combination of causes. These deteriorations have been able to build up and interact with the passing of time, slowly aggravating a situation that piece-meal repairs have not been able to arrest. The following can be distinguished:

- ◆ *"construction defects, i.e. stemming directly from the method of construction and/or the poor quality of the materials implemented;*
- ◆ *"induced" defects arising from various factors affecting the tunnel after construction.*

A change in the structure may have already been noted by the tunnel manager and led the manager to trigger a detailed inspection. If, during the course of the latter, deteriorations are discovered that had never been reported before, the likely cause of the development of the deteriorations at this stage can only be surmised based on experience. According to the severity of the deteriorations observed and when safety is not immediately threatened, a period of observation and, if possible, appropriate tests will make it possible to quantify the rate of deterioration, thus facilitating the determination of the final diagnosis.

At the end of a detailed inspection, two situations are therefore possible:

- ◆ the problem with the structure is clearly identified and the preliminary diagnosis is enough to establish a reliable diagnosis of the problem which should be validated by the tunnel owner;
- ◆ the causes of the deteriorations are not immediately obvious but the situation is nevertheless of concern; the lack of information prevents the establishment of a precise diagnosis; the tunnel manager, advised by specialists, then decides that additional investigations should be conducted in order to confirm the causes suspected at the end of the preliminary diagnosis; a list of investigation and test techniques is provided in **appendix 7**.

It is therefore important to not interpret individual deterioration but to address them holistically, taking account of all possible causes together with relevant parameters.

6.3 Final diagnosis

It can take several years after inspection to make the final diagnosis, if investigatory work was required. It must incorporate the causes of the deteriorations detected, their speed of change and the risks induced by them. The final diagnosis is only established when all the phenomena observed in the tunnel have been identified and understood. If this reveals clearly defined causal effects, it will be necessary to prioritise the consequences (danger for the users or residents, risks for the structures).

Dividing the tunnel into areas or sections (see chapter 7) makes it possible to link the deteriorations observed with the various structures that make up the tunnel. Correlations can then appear between areas where the same types of deteriorations are concentrated.

In its conclusions the final diagnosis must attempt to identify the main factors that are responsible for the deteriorations. In the most complex cases, the diagnosis can discuss the various hypotheses. It must be sufficiently comprehensive to permit the design of the repair or rehabilitation project to be undertaken.

Examples of deteriorations are presented below for several types of lining. They provide a framework for conducting identification and analysis.

6.4 Schematic diagrams for analysing deteriorations

6.4.1 Case with unlined excavations

Road networks sometimes include unlined tunnels (or sections of tunnels). If the type of problem is clearly identified (falling rock), predicting it is sometimes difficult. In addition, this type of problem is one of the major risks for the users.

The ground often changes unpredictably, causing large sections of rock to fall, especially in well-jointed hard rock. A specific structural and geological study can help identify the risk potential.

Preliminary diagnosis
Unfavourable ground conditions at the time of construction
<ul style="list-style-type: none"> ◆ Many discontinuities ◆ Presence of clay ◆ Rock subject to alteration
Deteriorations at time of construction
<ul style="list-style-type: none"> ◆ cracking around shot holes ◆ Incomplete scaling during construction or afterwards
Identification of deteriorations and of their development
Induced deteriorations
<ul style="list-style-type: none"> ◆ Loss of cohesion within the rock mass ◆ Fallen blocks ◆ Delamination
<ul style="list-style-type: none"> ◆ Risks
<ul style="list-style-type: none"> ◆ Falls of rock of various size
Development
<ul style="list-style-type: none"> ◆ Continued loss of cohesion within the rock formation if support is not provided
Additional investigations
<ul style="list-style-type: none"> ◆ Geotechnical and geological study
Final diagnosis
Analysis
<ul style="list-style-type: none"> ◆ Report on the causes of the deteriorations detected, their speed of change, the risks induced ◆ Opinion on the main factors responsible for deteriorations
Remedies
<ul style="list-style-type: none"> ◆ Scaling ◆ Rock support (bolts, sprayed concrete...) associated with scaling operations



Figure 14a: condition at the time of the first inspection



Figure 14b: condition three years later

Figures 14: Falling rock (these two illustrations show the difficulty in estimating the stability of large rock formations: the first inspection had not detected any immediate risk, except for the lower portion of the rock mass which later fell; indeed, about 100 m³ had fallen).

6.4.2 Case with lined excavations

Masonry linings

This type of lining is susceptible to defects of different types, which often complicate the identification of deteriorations. The worst of the masonry has progressively disappeared and has been replaced. That remaining is reaching such a degree of alteration, despite periodic repairs, that it would be unrealistic to want to continue extending its lifespan for much longer.

Moreover, masonry tunnels are often of small cross-section, which often results in congestion on certain major routes. Immediate repairs can be limited to what is strictly necessary for safety, provided complete rehabilitation, including in particular an increase in the tunnel cross-section, is scheduled to follow soon thereafter.

On the other hand, if there are no constraints due to traffic or clearance) and if the ground is not a cause of deteriorations, the masonry can be maintained in serviceable condition using simple techniques (re-pointing, grout injection, etc.)

Preliminary diagnosis
Unfavourable ground conditions at time of construction
<ul style="list-style-type: none"> ◆ Changing ground conditions not properly taken into account during construction
Deteriorations at time of construction
<ul style="list-style-type: none"> ◆ Poor quality of the equipment, of the stone and/or of the mortar ◆ Poor construction of the lining (voids, timber left in)
Identification of deteriorations and of their development
Induced problems
<ul style="list-style-type: none"> ◆ Degradation of the mortar leading to joints opening and weakening ◆ Deformation of the lining, especially with non-circular profiles ◆ Spalling if the lining is over stressed by ground loading
Risks
<ul style="list-style-type: none"> ◆ Impacts and contact from lorries (local deformation reducing the clearance gauge) ◆ In the case with mechanical damage, potential for falling pieces of masonry on the users ◆ Collapse of the structure
Development
<ul style="list-style-type: none"> ◆ Development of visible faults (generally slow and not readily apparent change in masonry that is often dirty) ◆ Creation of new deteriorations following unsuitable repairs
Additional investigations
<ul style="list-style-type: none"> ◆ More frequent visual inspections in areas identified as sensitive to degradation ◆ Short intrusive drilling (about 3 m) followed by use of borehole camera ◆ Measuring the stress with load cell (if spalling is detected)
Final diagnosis
Analysis
<ul style="list-style-type: none"> ◆ Review of the causes of the faults detected, their speed of change, the risks presented ◆ Assessment of the main factors responsible for deteriorations
Remedies
<ul style="list-style-type: none"> ◆ Slightly degraded masonry: drainage and repointing ◆ Highly degraded and/or deformed masonry: anchoring/bolting, localised reconstruction, grout injections, etc.

Non-reinforced concrete linings

Pre-diagnosis
Unfavourable ground conditions at the time of construction
<ul style="list-style-type: none"> ◆ Changing ground conditions poorly taken into account during construction
Deteriorations at time of construction
<ul style="list-style-type: none"> ◆ Very old concrete: generally heterogeneous but not very well compacted, permeable hence favours degradation at depth within the structure which can endanger the thinnest structures ◆ More recent concrete (not waterproofed): other than transverse shrinkage cracking which can lead to degradation as it permits inflows of water, no other critical faults shown ◆ Poor design of the construction joints ◆ Faults linked to waterproofing: these can, over time, affect the stability of some rings (areas of varying extent which ring hollow) ◆ Poor grouting ◆ Honeycombing, loss of fines and other concreting faults ◆ Concrete subjected to freezing and thawing, sometimes when first cast ◆ Poor resistance of localised or old repairs ◆ Alteration by the spreading of de-icing salt (especially at the base of the sidewalls)
Identification of deteriorations and of their development
Induced deteriorations
<ul style="list-style-type: none"> ◆ Chemical attack linked to the inflow of aggressive water, exacerbated where the concrete is permeable ◆ Loads from the surrounding ground manifested by cracks or spalling which can indicate the pattern of deformation of the structure ◆ Weakening or fracture through impact ◆ Loosening of surface patching
Risks
<ul style="list-style-type: none"> ◆ Falling of degraded concrete or debris ◆ Local cracking of the arch
Development
<ul style="list-style-type: none"> ◆ Development of signs of distress (generally slow change but can be sudden if the monitoring has not identified incipient instability) ◆ Creation of new deteriorations following unsuitable repairs
Additional investigations
<ul style="list-style-type: none"> ◆ Measurement of deformation (crack monitoring, convergence, levelling) ◆ Measurement of thickness of lining and supporting structure (radar, impact-echo combined with destructive controls) ◆ Profile measurement ◆ Investigative drilling , window sampling ◆ Measurement of stresses (load cell or flat jack) ◆ Laboratory tests (analyses of concrete, water, etc.)
Final diagnosis
Analysis
<ul style="list-style-type: none"> ◆ Explanation of the causes of the pathologies detected, their speed of change, the risks induced ◆ Explanation of the main factors responsible for deteriorations
Remedies
<ul style="list-style-type: none"> ◆ One-off repair of certain limited deteriorations (frozen areas, one-off inflows of water, specific deteriorations with joints between rings, etc.) ◆ Treatment of the entire lining due to general degradation of old concrete resulting from chemical origin (this type of degradation has not been encountered to date in recent concrete) ◆ Reinforcement, possibly complex, of the fractured lining (this remedy may not be enough if the rupture is due to ground loading)

Reinforced concrete linings

Pre-diagnosis
Unfavourable ground conditions at the time of construction
<ul style="list-style-type: none"> ◆ Adequate account not taken of changing ground conditions during construction
Deteriorations at time of construction
<p>Lack of concrete cover - reinforcement too close to the formwork (cast insitu concrete)</p> <ul style="list-style-type: none"> ◆ Honeycombing or loss of fines and other concreting faults ◆ Concrete subjected to freezing and thawing, sometimes when first cast ◆ Faults associated with waterproofing ◆ Poor grouting ◆ Poor resistance of localised or old repairs
Identification of deteriorations and of their development
Induced deteriorations
<ul style="list-style-type: none"> ◆ Corrosion of reinforcement and consequential bursting of the concrete ◆ Weakening or fracture through impact ◆ Loosening of areas of patching ◆ Chemical attack linked to the aggressive inflows of water, all more so deleterious in that the concrete is permeable ◆ Actions of the surrounding ground rapidly materialised by cracks or scaling which can indicate the way of deformation of the structure
Risks
<ul style="list-style-type: none"> ◆ Falling segments, parts of segments or debris onto the carriageway
Development
<ul style="list-style-type: none"> ◆ Development of visible signs of faults (foreseeable change if structural monitoring is conducted properly) ◆ Creation of new deteriorations following unsuitable repairs
Additional investigations
<ul style="list-style-type: none"> ◆ Measurement of deformation (crack monitoring, convergence, levelling, profile measurement) ◆ Measurement of the lining, measurement of the depth of carbonation ◆ Measurement of the corrosion of the reinforcement and back analysis in order to ensure the structure or parts of it retain adequate residual strength (ventilation slab support brackets, for example) ◆ Laboratory tests (analyses of concrete, water, etc.)
Final diagnosis
Analysis
<ul style="list-style-type: none"> ◆ Explanation of the causes of the deteriorations detected, their speed of change, the risks induced ◆ Explanation of the main factors responsible for deteriorations
Remedies
<ul style="list-style-type: none"> ◆ Removal of degraded concrete ◆ Passivation of the reinforcement ◆ Patching ◆ One-off repairs for certain limited deteriorations (frozen areas, one-off inflows of water, specific deteriorations with joints between rings, etc.)

Sprayed concrete lining

Pre-diagnosis
Unfavourable ground conditions at the time of construction
<ul style="list-style-type: none"> ◆ Changing ground conditions poorly taken into account during construction
Deteriorations at time of construction
<ul style="list-style-type: none"> ◆ Insufficient or irregular thickness of material that can lead to instability ◆ Poor cover of the welded mesh or insufficient fibre content ◆ Concrete subjected to freezing when placed
Identification of deteriorations and of their development
Induced deteriorations
<ul style="list-style-type: none"> ◆ Panels loosened by ground swelling or by freezing ◆ Excessive shrinkage leading to local cracking and hence instability of panels of concrete ◆ Localised bursting due to corroded reinforcement ◆ Weakening or fracture through impact ◆ Loosening of patches ◆ Chemical attacks linked to the aggressive inflows of water, all the more deleterious if the concrete is permeable ◆ Actions of the surrounding ground rapidly becoming visible through the appearance of cracks or by spalling which can indicate the method of deformation of the structure
Risks
<ul style="list-style-type: none"> ◆ Unreinforced thin lining: very quick to rupture in the event of ground swelling. Falling elements, parts of elements onto the carriageway
Development
<ul style="list-style-type: none"> ◆ Development of induced deteriorations (change is foreseeable if the monitoring is done very carefully) ◆ Creation of new deteriorations following unsuitable repairs
Additional investigations
<ul style="list-style-type: none"> ◆ Measurement of deformation (crack monitoring, convergence, levelling, measurement of profile) ◆ Measurement of the thickness of the lining ◆ Inspection for the presence of reinforcement (fibres or mesh) ◆ Laboratory tests (analyses of concrete, water, etc.)
Final diagnosis
Analysis
<ul style="list-style-type: none"> ◆ Explanation of the causes of the pathologies detected, their speed of change, the risks induced ◆ Explanation of the main factors responsible for deteriorations
Remedies
<ul style="list-style-type: none"> ◆ Removal of loose material ◆ Passivation of the reinforcement or patching using reinforced sprayed concrete ◆ Rehabilitation by improved drainage and, if needed, consolidation of the surrounding rock with bolts.

Special case with inflow of water:

These may require treatment, regardless of the type of lining, either because they have a harmful effect on the structure, or to ensure the safety of the users or because of the operating constraints they create.

6.5 Example of an analysis of deteriorations, diagnosis and repairs

The example of the Condes tunnel-canal (Haute-Marne) is a good illustration of the way in which a diagnosis can be established leading to a repair method that is adapted to the specific deteriorations that this tunnel was suffering from.

The deteriorations encountered in this structure are not specific to canal tunnels, but can be encountered in similar tunnels elsewhere.

6.5.1 Description of the structure

Located on the Marne to the Saône canal, the tunnel is located 4 km to the north of Chaumont (Haute-Marne). Built in 1884 in three passes (top heading, side walls and invert) divided section, it passes below a hill under an average cover of 20 m. The ground that it passes through is Bathonian limestone in horizontal, thick, homogeneous and hard bands.

The plan route is straight and the length of the structure is 308 m. The transverse profile of the upper portion of the arch is elliptical with a 16 m horizontal axis and a 5.15 m vertical axis. It rests on curved sidewalls, with a 5.34 m radius, located for the most part below water level in the canal. A curved invert (radius of 22.50 m) completes the profile over the entire length of the tunnel. The navigable passage is 11 m wide.

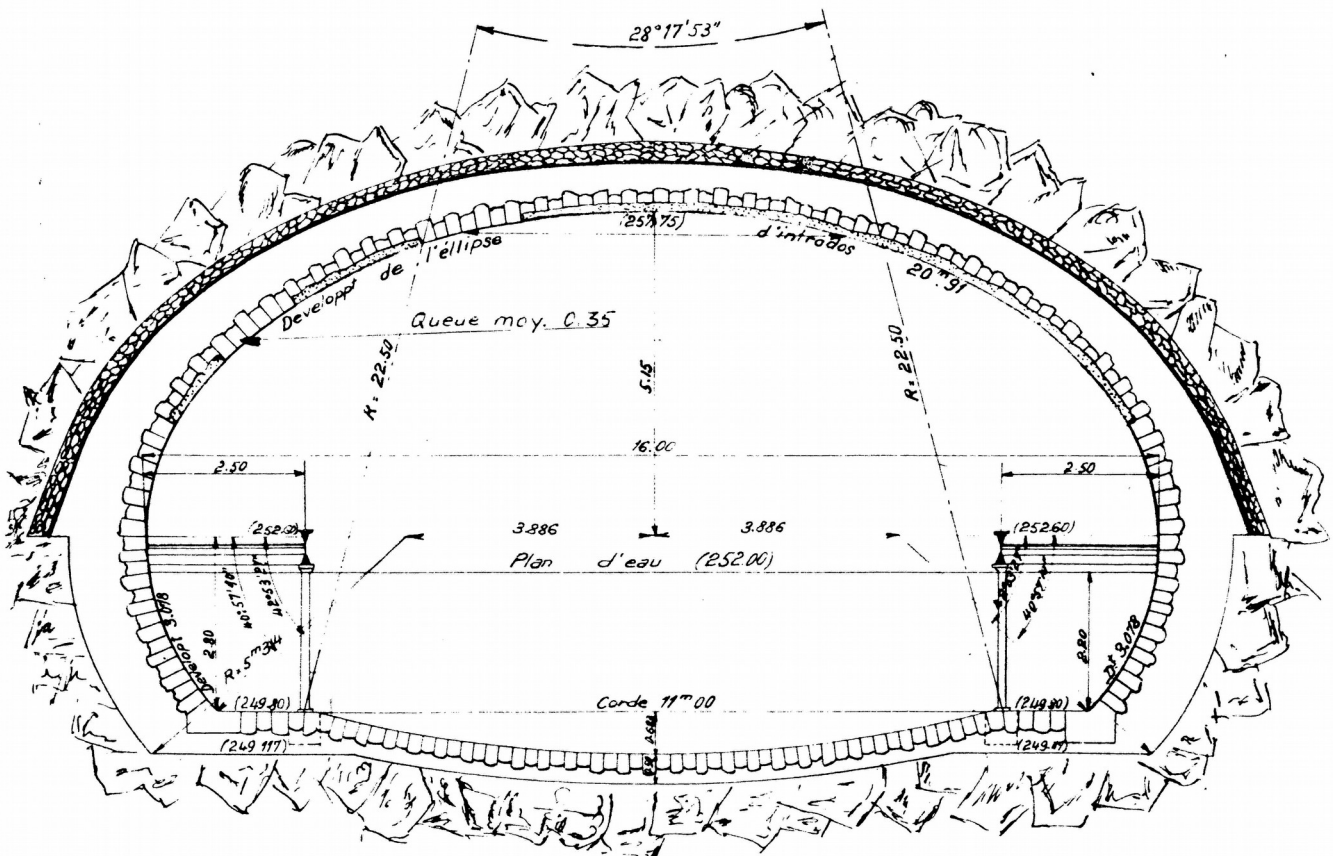

Figure 15: transverse profile of the Condes tunnel (archived document)

The masonry rubble lining is comprised of oolitic limestone of which the thickness varies from 1 m at the key to 1.50 m at the springer level. The invert has a supposed thickness of 0.50 m.

6.5.2 Investigations and survey

First detailed inspection (March 1988)

Tunnels lighting, located above the two longitudinal walkways, clearly allowed the general deterioration of the masonry arch and of the sidewalls to be seen.

The first detailed inspection of the arch above water level was conducted in March 1988. This visual inspection confirmed the fairly substantial deterioration of the lining, which had first been reported in 1910. Sections of masonry had apparently been falling on a regular basis creating cavities in the lining. This had resulted in an extensive loss of material which both in terms of depth and lateral extent. It was also noted that these deteriorations were present over the entire intrados. On the other hand, no other problem was visible, either in terms of cracking or substantial deformation. The invert was not inspected (difficulty in emptying the channel, thickness of the canal bed).

In light of the flatness of the arch, its thickness (and therefore its own weight), the presence of horizontal limestone bands above the tunnel, there was the possibility of substantial stress in the masonry which could cause local mechanical spalling of the masonry.

Second detailed inspection (October 1994)

The second detailed inspection took place in October 1994. Emptying of the channel as well as canal bed made it possible to inspect a portion of the submerged sidewalls and the invert.

With the arch, the lateral extent of the degraded masonry was very clear but the depth of the cavities did not exceed 25 cm.

The sidewalls located under the walkways had been rendered with a cement coating which was in very good condition apart from some delamination and a few cracks which were not related to the deteriorations of the upper portion of the tunnel. The exposed portions of the invert also showed a surface lining in good condition and without signs of cracking or rupture. The areas which had been below water were, as a whole, in a much better state than the areas which had been in the open air.

Surveys

In 1994, four convergence profiles each using 5 points were installed in the tunnel in order to detect any slow deformation of the profile.

Four measurement campaigns were conducted (October 1994, February, June and October 1995) in order to show the seasonal behaviour of the lining and possible deformation processes.

The first year of measurements only allowed for the observation of the seasonal "movement" of the monitoring stations which varied between -0.4 and + 0.6 mm, and which was small for an arch of this span.

The measurement campaigns confirmed the absence of deformation.

In December 1995, a campaign of 30 cores and borehole inspections was carried out at the arch in order to know the state of the masonry body.

The average thickness of the lining observed in the drilling was 0.60 m at the springer, 0.70 m at the haunch and 0.80 m at the key. Despite having a compressive strength (Rc) of 40 MPa, the masonry had visible signs of lamination in depth.

Rock was encountered at a depth of 1 to 2 m. The annular space was filled in with rubble bound with mortar in which a green grout could be seen. The residual voids were about 0.20 m. The excavation profile seemed to be highly irregular due to overbreak linked to the horizontal stratification. The limestone in place was hard (Rc greater than or equal to 25 MPa).

In conclusion, despite the actual thicknesses being less than shown by the data in the archives, the lining was reasonably homogeneous over its entire thickness.

In September 2000, a fifth measurement campaign was requested by the operator. The result confirmed the stability of the arch: no variation in chord base length had exceeded one millimetre in five years.

6.5.3 Diagnosis

The convergence measurements made it possible to eliminate the hypothesis that deformation of the profile was due to crushing. Indeed, if high stresses had generated the mechanical spalling this would have manifested itself at particular points of the transverse profile (here, the springers) although the inspections had shown a uniform distribution of the deteriorations.

The problem of the tunnel therefore lay primarily in the poor quality of the masonry. The loss of material initially introduced a risk for the users of the tunnel, but could also lead to weakening of the lining where a substantial cavity had formed extending beyond the first layer of masonry (35 cm). Where such faults had been identified suitable solutions had already been implemented, i.e.:

- ◆ filling voids in the cladding at the North portal (cement coating), which was still present and stable;
- ◆ injections of "cement slurry" in 1914 and 1958: although being of no use for strengthening the lining, the injections had filled in a portion of the voids and consolidated the masonry body, ensuring its long term preservation (confirmed by coring).

6.5.4 Rehabilitation project

The principal repair technique proposed was for reinforced sprayed concrete with welded mesh, over the entire intrados above water level and anchored to the lining. That should have made it possible both to secure the opening and to stop the degradation of the masonry.

6.5.5 Works

First section (in 2002, between MP150 and MP205)

The work comprised:

- ◆ removing the damaged material to a maximum thickness of 10 cm,
- ◆ spraying concrete order to fill cavities which had already been created,
- ◆ installing and anchoring welded mesh over the entire arch,
- ◆ spraying concrete using the dry method (thickness of 5 cm).

As a test, an experimental ring was created, between MP175 and MP181, out of fibre reinforced sprayed concrete without welded mesh.

Second section (in 2003, between MP50 and MP150, between MP205 and MP308)

The work comprised:

- ◆ removing the damaged material to a maximum thickness of 10 cm,
- ◆ spraying concrete to fill cavities that have already been created,
- ◆ the installation and anchoring welded mesh over the upper portion of the arch over 10 m of intrados,
- ◆ spraying concrete with metal fibres (thickness of 5 cm).

6.5.6 Conclusion

Following the lining work, a detailed inspection was conducted in 2004 to set the new "zero point" for monitoring.

The linings created are currently standing up well. The ring reinforced with metal fibres, has no signs of any particular deteriorations which could be linked to the absence of welded mesh.

No abnormal change has been observed to date.

7 HOW TO CONDUCT A DETAILED INSPECTION

7.1 How to prepare for the inspection

The methodology which follows applies particularly to bored tunnels. It is suitable however for all types of tunnels regardless of the method of construction or use (roads, railways, canals).

7.1.1 Scheduling

The intervention period on site is jointly agreed by the respective parties as many factors come into play (traffic, season, scheduled work, maintenance, type of marking, etc.). In particular, periods allowing the tunnel bore to be entirely closed to traffic during the inspection are to be preferred.

7.1.2 Study of existing documents

This first step is indispensable. The tunnel must be "learned" before going into it!

The inspector has to get to know the structure in advance by an in-depth examination of the archives or documents that are provided to him (construction methods, repairs, previous inspections, special monitoring, measurements and observations of all types, summaries or technical papers). In particular, the previous inspection report must be analysed carefully.

In the case of an initial detailed inspection or after major remedial work, the tunnel owner is responsible of the division of the structure into sections based on the geology, support structures, waterproofing and lining. At this stage, it is already possible to identify the sections that have given rise to deteriorations during construction or during repairs. The inspector must be aware of these and consider them as specific points that warrant special attention during the inspection.

Sometimes the division into sections is not carried out at the time the documents are given to the inspector. He must then request this from the tunnel manager. With regards to tunnels on the national road network not under private management, the contracting party can seek support from the Centre d'Etudes des tunnels to perform the division. An example of division into sections is provided in **appendix 8**.

For recent relatively-complex tunnels, for which the file on the structure may not have been compiled during the initial detailed inspection, a preliminary visit may be required, in order to meet with the tunnel owner and the his technical consultant, but also:

- ◆ to precisely define the parts of the structure to be inspected;
- ◆ to estimate the work load and the resources to be implemented;
- ◆ to incorporate the safety constraints imposed by the H&S manager on the site;
- ◆ to gather knowledge based on as-built drawings and on the recollections of those involved in construction.

In the case of a tunnel that has already been inspected, it is important to consult the documents concerning any work carried out since the previous inspection, as well as the annual assessments. The latter can provide a warning through the recurrence of significant incidents. Likewise, sensitive sections, subject to an agreed monitoring regime but not sufficiently critical to require to short-term interventions, may have already been identified.

7.1.3 Preparatory work

Work devoted to the inspector

The inspector must ensure that the documents in his possession are adequate to form the basis for precise background plans required for the survey of the structure. He should create these in a computerised format and, if the surveys on site have been completed on paper, print them on a scale greater than or equal to 1/100. The format of the drawings must allow them to be manipulated easily in conditions that are not always ideal (wet and windy surroundings).

Work devoted to organisational or operational services

The tunnel manager (organisational level) must ensure there is a chainage marking at 10m intervals as this is indispensable for the tunnel inspection (and related structures where applicable). Otherwise the inspector should ask for it to be set up (or refreshed) before the inspection. Appendix 9 specifies the particulars for this marking.

The tunnel manager operational level must facilitate free access for the inspection to all parts of the structure concerned, including the trafficked areas, ventilation ducts and drainage networks. No complex maintenance or washing of the structure should be scheduled to coincide with the periodic detailed inspection. Wherever possible, the removal of all or any part of added cladding is to be carried out before any inspection.

7.2 How to conduct the inspection

For non-road tunnels, the recommendations that follow differ only in the material resources that make it possible to reach the crown: platform and aerial basket on a specialised car (railway tunnels), barge equipped with scaffolding (canal tunnels).

7.2.1 The resources, the tools

Lighting

The lighting installed in the tunnels is not normally sufficient to allow for good observations to be made, especially of the crown. It is therefore essential to have additional lighting that is as powerful as possible. This lighting should be able to illuminate a large area of the lining: the observations and record drawings will be of greater precision, and the diagnosis as well.

For work on the ground in tunnels that are poorly lit or totally unlit or in galleries that cannot be accessed by a vehicle, it is very useful to have a mobile chassis on which to mount a small generator unit, provided with several floodlights.

In relatively tight spaces, such as ventilation ducts, the use of an internal combustion engine can be inconvenient and a source of pollution. In this case, the examination should be undertaken with the use of portable lighting only (headlamps, torches, backpacks provided with battery-powered lamps).



Figure 16: Backpack provided with lamps

When the inspection is carried out using a mobile elevating work platform (MEWP), it is recommended that the floodlights are located some distance from the observation station, and there is an adjustable spotlight next to the inspector.

The mobile elevating work platform (MEWP)

A MEWP is indispensable where contact must be made with the lining intrados; it cannot be examined solely from the carriageway.

The type of MEWP should be carefully selected as it determines the quality and the speed of the inspection. Indeed, inspecting an arch does not take place at regularly-fixed points, but through continuous observation, searching for deteriorations. It is therefore particularly important for the MEWP to be able to travel slowly with the basket in the raised position.

According to the CEN standard for machinery safety, there are three types of MEWPs:

- ◆ type 1 MEWPs: these are mounted on a trailer or support vehicle and are used as fixed stations (stabilisers on the ground); the carrier can only move if the platform is in the parked position;
- ◆ type 2 MEWPs: these are mounted on a support vehicle, and can be moved with the platform in the raised position (stabilisers folded back); the carrier is driven solely by the operator located in the basket;
- ◆ type 3 MEWPs: these are mounted on a chassis or self-powered base for which the travel function is controlled from the basket, regardless of whether it is raised or not.

MEWPs are also divided into two categories:

- ◆ category A: this is comprised of MEWPs that only rise vertically from their base:
- ◆ category B: this includes MEWPs on which the basket is mounted on an articulated or telescopic arm extending from a rotating turret all of which make it possible to cover a more extended area.

As they are linear structures, type 1 MEWPs are not suitable for tunnel inspection work.

A type-2 device allows for greater flexibility for the teams on the site as it can travel on the road as a normal vehicle. However, this type of device is not common.

A type-3 device is commonly found for rental in all regions. When in use, a driver is needed next to the inspector, so that the latter can concentrate on the observation and not on the steering.

Examining all the parts that make up a tunnel requires a lateral offset of the aerial basket that is only possible with a turret device, therefore a category B device (portals, parts of the arch located above areas where traffic is not possible, etc.).

In light of these considerations, a category 2B or 3B elevating work platform, combining a high-performance lighting system, is the most effective tool in terms of capability and output for inspecting road tunnels.

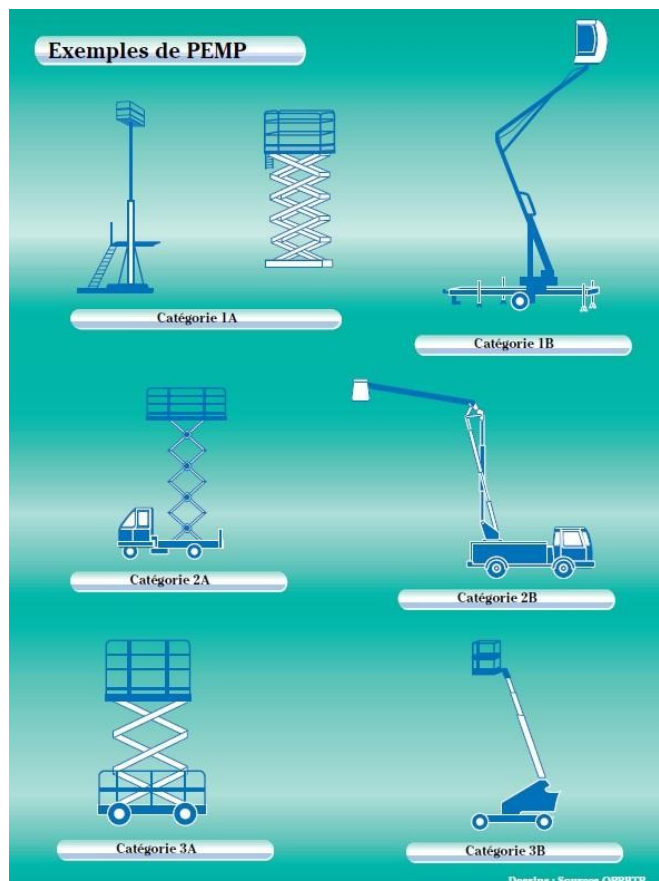

Figure 17: MEWP categories according to French recommendation R386 of the CNAMTS [source: OPPBTP]

When selecting a MEWP, ensure that it effectively meets the needs of the inspection (load capacity, height and offset capacities, etc.) and the working environment (stability of the ground, longitudinal and lateral slope, etc.)



Figure 18a: : aerial basket truck of the CETU (type 2B MEWP) fitted with floodlights



Figure 18b: type 3B aerial platform

Figure 18: various types of aerial platforms used to inspect tunnels

The hammer

This tool makes it possible to sound any type of rock or lining material. By listening to the sounds, hollow or not, emitted by the materials, tapping with a hammer reveals deteriorations that cannot be detected with the naked eye (voids, faults concerning compaction of the backfill, hardness of the joints, etc.). One must not be afraid to "demolish" a little in order to evaluate the depth of degradation. Its use is an integral part of the inspection process.

Despite any empiricism attached to hammer testing, this quick and inexpensive practice makes it possible to detect many signs and deteriorations, which is the purpose of an inspection. Geologist's hammers are recommended as the head and the handle are a single unit (structural continuity) and they have a pick end. In addition, their weight, at least 750 g, is enough to induce vibration in a lining up to 10 cm thick. Lighter hammers, of 300 g, can be used for very thin linings (up to 5 cm thick) but they do not perform as well with thicker linings.

The inspector should always use the same tool as he will "calibrate" his ear to the different sounds of the objects and his diagnosis will be refined.

Recording hammers now exist that measure the speed of the vibration of the part of the structure being subjected to the hammering in order to detect the presence of empty spaces or deep fracturing.



Figure 19: types of hammer recommended

Crackmeter

This tool makes it possible to measure the width of any cracks observed during the inspection and to monitor any change in the structure over time. There are various types of tools and devices which are more or less complex to operate. Some will preferably be used for measuring over long periods of time.

During the inspection, favour tools that are light, easy to handle and which can be used quickly such as plastic crackmeters.

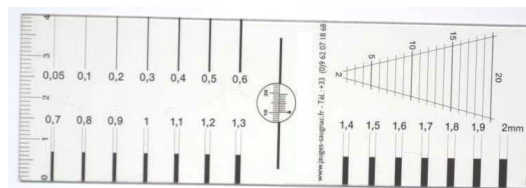

Figure 20: example of a crackmeter

The camera

Preferably of the reflex type and provided with a powerful flash, it is the essential tool for illustrating apparent deteriorations that will be reported in the inspection report. It must have a wide angle lens with a focal length of 18 or even 14 mm (which is equivalent to 28 or 24 mm in 24x36 format) in order to capture a relatively wide area when there is not much room to stand back from the surface being photographed. The device must also be able to take close-ups (macro mode) for details such as the opening of a crack for example.

The flash must have a guide number of at least 30 because many dirty or encrusted surfaces reflect light poorly. The purpose of an offset flash is to retain the contrast that can be seen with the naked eye (wet cracks or uneven areas, etc.) and which fade out if the light is too bright.

Measuring tape

This is a tool that allows for reference points to be made in a tunnel that does not yet contain any markings (to be avoided at all cost) or to measure dimensions of parts of the structure. For reference markings, in order to limit the cumulative errors, a tape length of 50 m is recommended.

Personal protective equipment (PPE)

This is required for all interventions on the road network, especially:

- ◆ safety shoes,
- ◆ gloves,
- ◆ yellow reflective vest (this colour is the most visible in areas with artificial lighting),
- ◆ helmet with chinstrap.

In addition to PPE requirements appropriate traffic management measures should be implemented depending on the environment in which the inspection work is taking place (closure of the structure to traffic, lane closures, diversions, etc.).

Other tools

Other tools that are easy to use and which can be of use during the inspection: double pocket tape measure, calibrated vessel for water flow monitoring, thermometers, conductivity meter for inflows of water, crack width measuring device of various sorts both self powered and manually operated, reinforcement detectors for concrete, etc. This is not a complete list and depends on the context of the inspection. All of these tools should be light, easy to manipulate and quick to use.

7.2.2 The inspection method

Planning of the inspection

Inspecting an arch has to be conducted in several passes: a passage on foot for each sidewall and at least one pass at height in an aerial basket for the roof section and often more depending on its width.

It is preferable to begin the inspection of an arch from the ground. The marking plates fixed on the sidewall provide for quick and accurate reference system for details of structures which the inspector decides to note as part of the intrados survey. It is sometimes easier to accurately locate a problem on the roof section from the ground. Work in an aerial basket then allows the arch to be inspected further, deteriorations detected from below to be characterised or examined more closely, and further faults to be discovered.

Surface cladding (or panels) and the elements for passive protection of the lining can be inspected. Whenever possible, their fastening system should be checked. The inspector must however keep in mind that a problem with the cladding or the passive protection does not give any indication as to the condition of the underlying structure. When in doubt, he can ask the tunnel manager to for the relevant elements to be removed to gain access to the structure. Removing and reinstalling the surface cladding is the responsibility of the tunnel manager.

For an operational tunnel where traffic diversionary routes exist, it is recommended to close the tunnel entirely (the ideal situation for an inspection). When this really isn't possible, the work is carried out with traffic, having first used appropriate traffic management procedures to put in place a lane closure. One section of the arch is therefore inspected in full (from the ground and from a MEWP basket before repeating the exercise for the other lane(s)).

For the largest tunnels that have secondary structures (e.g. ventilation ducts, evacuation galleries, technical shafts...), the inspection team can split up and work in parallel on each part of the structure in order to minimise intervention time. The same applies to the inspection work on foot or from an elevating access platform. Additional time must however be reserved for communication between the teams (debriefing) or in order to supplement the examination of areas that so warrant.

The examination of carriageways and walkways, surface water drainage systems (so far as they are accessible) must not be forgotten nor any portal structures and their immediate surroundings. For the latter, the examination can be conducted solely from an appropriate aerial platform, preferably during daylight hours.

Visiting parts of the structure that are difficult to access

Certain parts of structures are difficult to access or traverse (very low ducts, shafts, annular spaces between arches, surface cladding). If continuous surveillance here suspects deteriorations, the tunnel manager must provide the inspectors with the resources needed to perform a thorough and comprehensive examination.

Where continuous surveillance and the annual inspections (for which a model report is provided in **appendix 10**) do not detect any deteriorations, these parts can be examined at every second inspection.

Voids which cannot be inspected directly require the use of special techniques (for example, sewer cameras for drainage and surface water drainage networks in order to check for blockages or breaks).

These relatively complex operations can be suggested by the inspector, in light of the deteriorations detected, but should be left to the initiative of the tunnel manager.

List of observations

Practical inspection of a tunnel consists of detecting faults and deteriorations in the various parts and sub-parts of which it is comprised.

Each problem identified is rated and marked with two metric points (MP) indicating where it begins and ends. An isolated problem can be marked on the survey by its MP.

Regardless of the information that has already been acquired through studying the documents, the inspector has to examine everything that is visible on the intrados, on the carriageway, at the portals and outside the tunnel. He must also focus his attention on the points reported by the tunnel manager (organisational and operational services); and either confirm or dismiss them through their own observations.

He must record, on the drawings of the structure, the structural details and the deteriorations observed and note any sign that allows him to assess the situation and to develop a preliminary -diagnosis. There is therefore some prioritisation required which sometimes can be difficult, in light of the number of the visible "defects". His listing is a selection (and therefore already an interpretation) intended to reveal sensitive areas, and then to identify the deteriorations.

It is therefore very important that inspectors have good experience of the development of structural deteriorations (symptoms, causes, possible consequences), as well as a good knowledge of the behaviour of structures, in order to be able to detect a major developing problem over time from signs which are not always evident.

Knowledge of the construction methods originally used for the tunnels will allow for a refined diagnosis to be made. Indeed, construction methods for masonry tunnels can have different influences on the behaviour of the structure. On the contrary, systematic spalling of the concrete, as a result of formwork operations, is a fault that has to be noted but will not be considered as a problem, if there is no change with time.

For unlined sections of tunnels, the inspection is similar to a geological survey (nature of the various ground types, fracturing), during which priority must be given to looking for areas of rock instability that form a danger for the users. Using a skilled geologist is indispensable.

Many photographs, wide angle and close-ups, should be used to supplement the surveys. However, for better use in the office and better results, photographs must be able to be located easily. In general, a wide angle photograph allows the problem to be located in the tunnel; a close up view makes it possible to appreciate the size of it as long as a scale mark appears in the image.

Surveys can also be supplemented by scan images, thermographic measurements, profile survey or other survey methods with a graphic output (these methods are covered in appendix 7). Documents obtained as such provide valuable assistance for an objective visualisation of the intrados but they do not replace a visual "contact" examination.

In any case, a precise description is the essential starting point for a good diagnosis.

At the end of the intervention, the inspection manager draws up a report on the observations and can issue a preliminary opinion to the local manager of the structure (operational level). Where applicable, he formally reports to operational and strategic management on any problem that involves the safety of the users or the stability of the structure. If necessary, he should suggest provisional operational measures to be taken.

7.2.3 Office work

This is the responsibility of the inspector and consists of recording the deteriorations detected in the field on drawings, using CAD key-entry tools, and in drafting the inspection report.

Intrados survey

This is primarily the survey wherein the inspector notes and illustrates all of the deteriorations identified.

The baseline intrados survey is established during the first detailed inspection. It must then be kept up to date with the greatest of care, using the observation reports created during the various inspections or visits, and with the indication of the work carried out and its precise location. These updates must be able to be carried out by inspectors other than those who conducted the initial survey, but with absolutely identical baseline survey. Archiving the plans and documents that were used to draw them up is also an important part of the inspector's work.

It should be possible for the survey to be interpreted without ambiguity by any person that needs to consult it for the purposes of an intervention, regardless of the nature. It must clearly show the areas of the structure which affect the safety of the users or the integrity of the structures.

Finally, a coherent policy should be defined and put into practice for the monitoring and maintenance of a set of tunnels. This will be facilitated through the use of surveys that are fully comparable.

Figures and symbols for codifying materials, equipment and deteriorations are presented in **appendix 11**. They facilitate the interpretation of the surveys and are to be used in preference to all other representations.

Inspection report

The purpose of this report is to report to the manager, with as much precision as possible, on the state of the structure on the date of inspection.

If deteriorations are observed, it presents a preliminary diagnosis by clearly showing the various sections and areas identified in the structure. In simple cases, the inspection report itself can present the diagnosis and, if needed, include suggestions on the types of repair that can be considered. However, establishing the repair project is a separate step which is subject to a separate study.

In more complex cases where there are still uncertainties, the report should suggest measurements or additional investigations to be undertaken. Further investigation, to be agreed with the tunnel manager, will make it possible to progress towards the final diagnosis.

When this is the case, the report should mention the provisional or safety measures that were suggested at the end of the inspection.

A typical framework for drafting an inspection report is provided in **appendix 12**.

8 IQOA EVALUATION

The general principle for assessment and rating using the IQOA-Tunnels method is the tool defined by the (French) State for the management and maintenance of all of its bored tunnels present on the national road network.

This principle can of course be applied to tunnels managed by other authorities or tunnel management companies and there are also similar tools available on the market.

The IQOA – Tunnels methodology provides an approach that is tailored towards bored tunnels by taking account of specific characteristics of the structure and of the surrounding ground; this approach does however remain consistent with the IQOA – Cut-and-cover tunnels methodology.

This chapter describes this assessment and rating procedure. Examples of rating a single bore and a tunnel with twin bores are provided in appendix 13 of this guide.

8.1 Assessment principle

Assessing a tunnel is carried out using detailed inspections and, where applicable, additional investigations. The IQOA rating of tunnels suggested by the inspectors at the time of detailed inspections is comprised of:

- ◆ a "Civil engineering" rating,
- ◆ a "Water" rating.

Document 40 "Tunnels – Civil engineering works and equipment" from October 2012, conforming to ITSEOA, requires that these ratings be updated every three years by the tunnel management. Scores are modified in the procedure where new elements warrant it.

The general principle for assessing and rating a tunnel using the IQOA method is based on:

- ◆ dividing the structure into bores and sections,
- ◆ a breakdown of the sections into parts and sub-parts,
- ◆ an assessment of the elements that comprise the parts or sub-parts,
- ◆ a rating according to the prescribed condition assessment classes (Refer to 8.3),
- ◆ zoning for the structure, dividing it into areas with identical rating.

Ancillary structures, such as defined in chapter 3, do not all fall under the IQOA-Tunnels method. They are however inspected at the same time as the tunnel with possible additional support from competent specialists. Some of these structures, such as supporting walls, can be subject to an evaluation according to the IQOA-Walls method.

Buried structures with a design and construction methodology identical to those for bored tunnels (safety and evacuation galleries, local technical rooms, ventilation stacks) are assessed according to the IQOA – Tunnels method

8.2 Dividing

The general principle for assessing and rating a tunnel using the IQOA method is based on a division of the structure into bores, the bores into sections and then in defining the various parts of the structure by section.

8.2.1 Bores

A tunnel is comprised of one or more bores containing one or more traffic lanes. A bore contains two ends called portals.

8.2.2 Sections

A section is a homogeneous section of a bore in terms of type of structure and geological context. It is defined by two metric points (MP) indicating where it begins and ends.

The tunnel can also contain a safety gallery, evacuation galleries and cross passages which are cut into sections based on the same criteria as those used for the bores.

Ancillary structures influence the subdivision of the bores but are not integrated into them. Each of these structures can have a division that is adapted to its nature.

Defined at the time of construction, the sections do not vary over time except in exceptional cases such as, for example, complex repairs. This division process forms the basis for all monitoring activities.

8.2.3 Areas

An area is a section of tunnel bore defined by two metric points (MP) indicating where it begins and ends. It is characterised as a homogeneous section with regards to the IQOA rating. Defined during the initial detailed inspection, or during the first inspection that applies the IQOA assessment, by the tunnel manager. Areas can vary over time, depending on changes in the deteriorations and observations arising from monitoring. Areas are generally modified only after a periodic detailed inspection (PDI) but can be modified between two consecutive inspections.

The areas, which reflect the analysis after the inspection, are established by the inspector and submitted to the tunnel manager for validation.

Areas and sections are two longitudinal subdivisions of the tube, you can move from one to the other via metric points.

By convention, the minimum length of a rating area is equal to one metre. In the case of a localised problem, it is centred on the latter.

8.2.4 Parts and sub-parts for the civil engineering works

A section is broken down, for the purposes of the inspection, into parts and sub-parts. For civil engineering works, three parts can be distinguished:

- ◆ "Area of influence" part which characterises the tunnel's environment,
- ◆ "Structure" part,
- ◆ "Civil engineering equipment" part".

The "Area of influence" part

The area of influence characterises the tunnel's physical environment. Any modification in the space can directly affect the structure. The "Area of influence" part includes the features, close to the structure, that influence or that can influence its behaviour. For tunnels, this can be:

- ◆ the surrounding ground (presence of faults, karsts, expansive soils, unstable slopes at the structure portals, etc.),
- ◆ vegetation present at the portals,
- ◆ existing features or those occurring in the immediate vicinity of the tunnel and which can modify the behaviour of the rock formation and have repercussions on the structure (quarries, new lanes, etc.).

These features can be noted separately or as a whole (in the second case, the "Area of influence" is not broken down into sub-parts). These are covered by comments, following the inspection of the other parts of the tunnel, especially the portals.

The "Structure" part

The "Structure" part includes all of the load bearing elements of a tunnel (the parts that carry the loads and transmit them to the surrounding ground) and include the various sub-parts listed below:

- ◆ roof section,
- ◆ sidewalls (left and right, north and south, east and west, etc.),
- ◆ invert.

The "Civil engineering equipment" part

The "Civil engineering equipment" part includes all the civil engineering elements for the finishing work, included in the structure and intended:

- ◆ for ensuring the operation of the structure,
- ◆ for ensuring the safety and the comfort of the users,
- ◆ for protecting the tunnel from external attack,
- ◆ for improving the structure aesthetically.

The civil engineering equipment, normally, cannot be separated from the structure, which distinguishes it from operating and safety equipment such as lighting and ventilation.

The "Civil engineering equipment" part is broken down into as many sub-parts as there are pieces of equipment in the tunnel

An incomplete list is provided below:

- ◆ architectural elements (architectural features and cladding, etc.),
- ◆ beams for limiting the clearance gauge,
- ◆ barriers/walls for preventing smoke circulation ,
- ◆ retaining devices,
- ◆ walkways,
- ◆ ventilation ducts (if they are not incorporated into the structural elements),
- ◆ drains, culverts and inspection chambers,
- ◆ pavement.

According to the type of structure, some of the "Structure" and "Civil engineering equipment" sub-parts may not exist. For example, ventilation ducts are not present in all tunnels.

8.2.5 Parts and sub-parts for water

The principle of a "water" category makes it possible to separately assess the state of the structure of the civil engineering works and the important parameter which is the presence of water.

The "Water" category makes it possible to indicate the presence of water and to draw the attention of the tunnel manager, as water can constitute a hindrance or a danger for users. On the other hand, the consequences that it can have on the structure through the appearance or the aggravation of deteriorations are taken into account in the assessment of the civil engineering works.

For the purposes of the inspection, the "Water" part is divided into different sub-parts which are:

- ◆ the roof section,
- ◆ the sidewalls (left and right, north and south, east and west, etc.),
- ◆ the carriageway.

8.3 Rating principles

8.3.1 State classes for an area

"Civil engineering" classes

The condition of a tunnel area is characterised by 5 classes whose definition is based on the type and severity of the deteriorations affecting the structure.

The indication NE (not evaluated) may be used when rating a section or sub-section which is not visible or cannot be inspected using traditional inspection techniques. This indication must remain exceptional, and must be justified in the inspection report or when updating ratings.

The classes are listed below.

Class 1

Area in good visual condition.

Class 1 areas only require routine maintenance and scheduled specialised preventive maintenance.

Class 2

Area with minor deteriorations (in the area of influence, on the structure or on civil engineering equipment), which do not endanger the stability of the structure and do not endanger the stability of the solid structure.

Class 2 areas may require non-urgent specialised corrective maintenance in addition to the maintenance required for class 1 areas.

Class 2E

Area including class 2 deteriorations (on the structure or in the area of influence), which could degrade and increase in extent, endangering the stability of the structure.

or

Area including civil engineering equipment which has been seriously altered or whose stability may be compromised.

Class 2E areas require specific monitoring and urgent specialised corrective maintenance to prevent the rapid development of more substantial deteriorations in the structure or to repair damaged civil engineering equipment, in addition to the maintenance required for class 1 areas.

The index "E" reflects possible short-term downgrading in the condition of the area.

Class 3

Area in which the deteriorations detected indicate that the structure has been altered or that the stability of the area in question is likely to have been compromised.

Class 3 areas require non-urgent protective, repair or reinforcement works. A rapid diagnosis is necessary.

Class 3U

Area in which the deteriorations detected indicate that the damage is deep and that the overall stability of the area has been compromised on the short- or medium- term.

Class 3U areas require urgent repairs to ensure the long-term survival of the structure or prevent any rapid development of the potential deteriorations. Works must generally be preceded by investigatory operations and surveys to ensure suitability for local geotechnical conditions, which are often poorly known.

The index "U" reflects the urgent nature of the actions to be carried out.

Indication "S"

This additional indicator "S" is allocated to one of the above 5 classes when specific defects or deficiencies detected in the area, regardless of the section in question, can endanger the safety of users and hence require urgent remedial action .

The additional indicator "S" reflects the existence of a defect in a section of the structure which has an influence on the safety of users and not a non-conformity with safety rules or an inadequate level of safety.

"Water" categories

Note: Note: the "Water" categories defined in this guide differ substantially from those given in the Road tunnel civil engineering inspection guide (Guide de l'inspection du génie civil des tunnels routiers) published by CETU in 2004.

The condition of a tunnel area can be characterised by 3 classes whose definition is based on the extent and form of the presence of water. The influence of water on the condition of the structure is no longer taken into consideration in this rating (evaluated under the "Civil engineering" class).

The indication NE (not evaluated) may be used for areas where it is not known if water is present (absent, invisible or cannot be detected using traditional inspection techniques) such as, for example, water inlets behind secondary cladding. This indicator must remain exceptional, and must be justified in the inspection report or when updating ratings.

The "Water" rating proposed by the inspector reflects the presence of water on the date of the site inspection. The manager is encouraged to modify this rating by referring to knowledge of the structure and continuous surveillance and to base action on the most negative condition detected during the year. The "Water" rating is the result of observations and does not require any specific knowledge of engineering structures.

The classes are listed below.

Class 1

Area with no visible water flow;

or

Area in which only dry tracks or damp stains are detected on cladding or pavements.

Class 1 areas only require routine maintenance and specialised preventive maintenance for drainage and pollution control networks.

Class 2

Area with light water flow:

- ◆ drips (any flowrate),
- ◆ local puddle with a depth not exceeding five millimetres,
- ◆ damp stain on the tarmac,
- ◆ continuous flow forming a film of water, running down the lining, with a depth less than one millimetre.

Class 2 areas must be subject to regular surveillance by the managing service in addition to the actions required for class 1 areas.

Class 3

Area with heavy water flow:

- ◆ continuous flow forming a film of water, running down the lining, with a depth more than one millimetre.
- ◆ water ingress under pressure,
- ◆ continuous flow running on to the tarmac (any flowrate),
- ◆ puddle with a surface area more than 10 square metres or a depth more than five millimetres.

Class 3 is used when the intensity of a single water inlet or the volumes of water from wide surface areas are significant. This will require specific remedial works to be undertaken, relying on the safety measures to be put in place by the managing service.

Indication "S"

This additional indicator "S" is allocated to one of the above 3 classes when the presence of water in the area can endanger the safety of users and requires urgent remedial action.

The indication S is specifically used when the presence of water:

- ◆ *in freezing conditions, could lead to the formation of icicles, black ice or sheet ice on the tarmac or adversely affect the use of safety devices;*
- ◆ *due to minerals in solution, could result in a lack of skid resistance for vehicles (e.g., calcite removing the texture depth of the wearing course);*
- ◆ *due to the absence or blockage of drainage, could present a danger for road traffic (e.g. flooding of the road).*

8.3.2 Summary table of IQOA scores

In order to have a general view of the state of a tunnel, the IQOA scores for the various parts or sub-parts are summarised in the form of a table. This table can be set up on the basis of the table for the subdivision of the structure although remember that sectioning and dividing into areas are independent.

The table can also be established automatically with computer software using the scores assigned for the various parts of the structure and the MP associated with these scores.

8.3.3 "Civil engineering" rating

"Area of influence" rating

The rating for this part is created using the deteriorations (cracks, deformation, local collapse, etc.) detected in the area of influence such as defined above. These can be deteriorations affecting various elements such as the ground, the carriageway, road equipment (lampposts, sign posts, etc.) or even vegetation. They can be signs of instability of the tunnel faces or adjacent slopes (blocks of rock falling onto the traffic lanes, landslides, etc.).

The main deteriorations concerning the area of influence, their possible origins and the associated ranges of condition classes are provided in **appendix 14**. This is of course not a complete list. For all of these deteriorations, the condition class can receive the note S.

"Structures" rating

The rating for the "Structures" part is obtained using a summary of the ratings of its various sub-parts defined in 8.2.4. The rating for a sub-part is made using the apparent deteriorations detected on its various elements using the "Catalogue of deteriorations" - book 2 of this guide.

The rating of a "Structures" sub-part falls into one of the five state classes from 1 to 3U and can receive the note S.

"Civil engineering equipment" rating

Only the civil engineering equipment is assessed and rated according to the IQOA method; the operating and safety equipment (fire fighting network, ventilation fans, etc.) do not fall within the scope of IQOA-Tunnels. Monitoring and evaluation for them is defined in Document 40 and its appendices available on CETU's website (www.cetu.developpement-durable.gouv.fr).

The rating for the "Civil engineering equipment" part is obtained using a summary of the ratings of its various sub-parts defined in 8.2.4. The rating for a sub-part is made directly from the deteriorations detected.

The main deteriorations concerning civil engineering equipment, their possible origins and the associated ranges of state classes are provided in **appendix 15**. Contrary to the "Structures" and "Area of influence" parts, the rating of a "Civil engineering equipment" sub-part is solely part of one of the three first condition classes (1, 2 or 2E) but can receive the note S.

Civil engineering equipment often includes discrete elements which are of small size in comparison to the length of a tunnel, the rating area for such an element is taken as one metre and is marked via its MP (chamber, beam for limiting the clearance gauge, etc.)

8.3.4 "Water" rating

The "Water" rating is obtained from a summary of the ratings of its various sub-parts: the roof section (or the ventilation slab), the sidewalls, the carriageway. The rating for each sub-part is directly linked to the importance of the presence of water and the form in which it manifests itself.

This rating includes three condition classes (1, 2 and 3) and can receive the note S.

8.3.5 First aggregation of the IQOA scores by constituent part

This first aggregation makes it possible to have a general view of the state classes assigned to each constituent part and sub-part based on the sectioning retained for the structure.

In principle, the most unfavourable state class assigned to one of its sub-parts is taken as the state class of the part for the MP under consideration.

This aggregating of IQOA scores shows, in addition to the condition classes, the note "NA" (not applicable) which indicates that the element is not part of the breakdown of the section, as well as the note "NE" (not evaluated).

Recall that the note "NE" shows the fact that the part or sub-part in question was not evaluated between two MPs. Such an indication must remain exceptional and be justified in the inspection report or in the conclusions when updating ratings.

For the aggregating of ratings, the notes "NA" and the IQOA condition classes are prioritised in the following way:

- ◆ for civil engineering works: NA < 1 < 2 < 2E < 3 < 3U
- ◆ for water: NA < 1 < 2 < 3.

The note "NE" does not give any indication as to the condition of the part or sub-part that was not evaluated.

8.3.6 Second aggregation and summary of ratings

This second aggregation is a statistical presentation of only of the "civil engineering" and "water" ratings obtained via the first aggregation applied to the total linear length of the bore and, where applicable, to the linear length for the entire tunnel.

The principle is to add the lengths of bore or tunnels assigned with identical IQOA scores (from 1 to 3U for civil engineering, from 1 to 3 for Water). A table then shows the proportion as a percentage of each category assigned out of the total for each bore and for the tunnel.

The tables, presented in **appendix 13**, illustrate the two aggregations and the summary of the IQOA scores in the cases of a single bore tunnel and of a twin bore tunnel.

This summary is also useful for the CETU which draws up on behalf of central government an annual assessment of the IQOA evaluations conducted on the parts of the national network not under private management.

9 BIBLIOGRAPHY

9.1 Instructions

[1] *Technical instruction for supervision and maintenance of engineering works (Instruction technique pour la surveillance et l'entretien des ouvrages d'art (ITSEOA)) – General arrangements applicable to all structures (booklet 0)* – Service for the study of transports, roads and their developments (SETRA), December 2010

[2] *Instruction technique pour la surveillance et l'entretien des ouvrages d'art (ITSEOA) – Structure dossier (booklet 1)* – French Central Laboratory of Roads and Bridges (LCPC), 2000 [currently being revamped]

[3] *Instruction technique pour la surveillance et l'entretien des ouvrages d'art (ITSEOA) – General points on monitoring (booklet 2)* – SETRA, December 2010

[4] *Instruction technique pour la surveillance et l'entretien des ouvrages d'art (ITSEOA) – Auscultation, reinforced monitoring, high surveillance, immediate safety or safeguarding measures (booklet 3)* – SETRA, December 2010

9.2 Guides and recommendations

[5] *Booklet 40: Tunnels – Civil engineering works and equipment* – Centre d'études des tunnels (CETU), October 2012

[6] *Road tunnel civil engineering inspection guide – From the problem to the diagnostic* – The CETU Guides, CETU, 2004

[7] *Feedback on repairing of civil engineering works of bored tunnels* – The CETU Guides, CETU [currently being drafted]

[8] *Catalogue of problems in underground structures – Recommandations de l'AFTES sur la réhabilitation des ouvrages souterrains (AFTES recommendations on rehabilitation for underground structures)* – Tunnels et ouvrages souterrains, hors-série no. 3, association française des tunnels et de l'espace souterrains (AFTES), 2005

[9] *Treatments for water stoppages in underground structures* – Tunnels and underground structures no. 194/195, AFTES, March-June 2006

[10] *Fire behaviour of road tunnels* – The CETU Guides, CETU, 2005

[11] *Highway and Rail Transit Tunnel Inspection Manual* – U.S. Department of Transportation, Federal Highway Administration and Federal Transit Administration, 2005

[12] *Tunnels: inspection, assessment and maintenance* – Construction Industry Research and Information Association (CIRIA), 2009

[13] *Evaluation of structures – IQOA cut-and-cover tunnels – methodological guide* – SETRA, May 2011 (draft version)

[14] *Evaluation of structures – IQOA cut-and-cover tunnels – inspection guide* – SETRA, May 2011 (draft version)

9.3 Internet sites

Centre d'études des tunnels (CETU):

www.cetu.developpement-durable.gouv.fr

Service for the study of transports, roads and their developments (SETRA):

www.setra.developpement-durable.gouv.fr

French Association for Tunnels and Underground Spaces (Association Française des Tunnels et de l'Espace Souterrain (AFTES)).

www.aftes.asso.fr

10 APPENDICES

10.1 Appendix 1: Logic diagram of the organisation of the monitoring of the civil engineering works of tunnels

Note: this appendix includes appendix 2 of the Booklet 40 "Tunnels – Civil engineering works and equipment" from 2011.

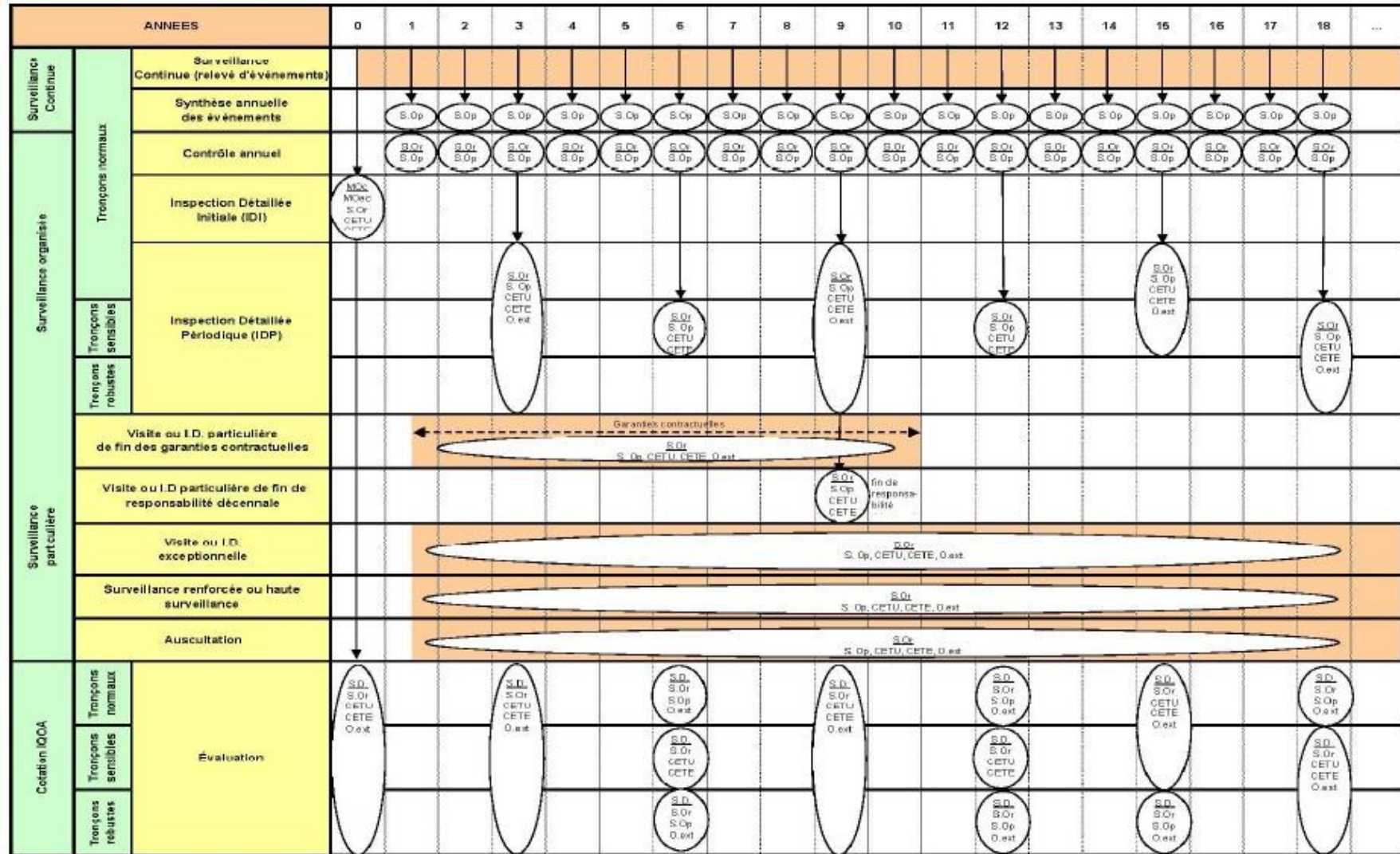

Nota : Le CETU intervient pour les tunnels creusés.
Le CETE intervient pour les tranchées couvertes.
Les intervenants soulignés ont l'initiative de l'action.

Signification des abréviations et des sigles

- S.D. Service décisionnel
- S.Or Service organisationnel
- S.Op Service opérationnel
- O.est Organisme extérieur
- CETE Centre d'études techniques de l'équipement
- CETU Centre d'études des tunnels
- MOC maître d'ouvrage des travaux de construction ou de réparation
- MOec maître d'œuvre des travaux de construction ou de réparation

10.2 Appendix 2: Intervention methods – Elements of a model specific technical clauses for a detailed inspection (DI) of a tunnel

10.2.1 Preliminary work to be carried out by the managing contracting party

The list of structures that are to be subject to a detailed inspection (DI) is set down at the beginning of the year by the decision-making department. The organisational service, in liaison with the operational service, must then examine the conditions for intervention for each structure:

- ◆ signs and personnel required,
- ◆ prior cleaning in the vicinity of the portals, access points and cladding of the structure,
- ◆ inform the managers of neighbouring roads or structures

The organisational service establishes the list of documents available and required for the inspection and makes them available to the inspection team. In liaison with the operational service, it checks for the existence of reference marking at 100mm intervals and makes sure that it is in good conditions (see **appendix 9**). Otherwise, it has reference marks set up in advance of the inspection programme.

10.2.2 Inspection team

For the national road network not under private management, the organisational service give priority to calling upon the CETU. Exceptionally, it can request intervention from either another specialised organisation such as the “States scientific and technical network” (RST), or from a private service provider. In both cases, the organisations must be able to justify the experience and skills of their personnel defined in chapter 2 of this guide.

The entire detailed inspection must be defined by a qualified engineer who has received specialised training in the field of tunnels. He manages the drafting of the report. He is responsible for the analyses and the conclusions to which he contributes.

Recall that the team of inspectors must be managed by a person at a higher technician level, with at least 3 years of experience in detailed inspections in tunnels, or by an engineer who has had at least one year of experience in inspection.

In addition when the tunnel or a part of the tunnel is unlined the tunnel inspection team must include a team member competent in geology.

The entire team must have received skills training in the civil engineering inspection of tunnels.

When an inspection is entrusted to a private service provider, the candidates, at the time of the consultation must provide as support for their bids:

- ◆ The curriculum vitae and training certificates for the members of the inspection team who will actually be in the field as well as of the inspection manager
- ◆ **possibly examples of reports that have been drawn up in the past.**

Additionally the order has to specify that the service provider who undertakes the detailed inspection should to establish a quality plan (QP) which will enable the organisational service to provide the material resources that the service provider has, the particulars for executing its future mission and of the internal control that it has set up.

10.2.3 Preparing the intervention

The organisational and operational services have to define, jointly in agreement with the inspection manager, the means of access required and the schedule for the intervention. The organisational service can then conduct, with the inspection team, a preliminary visit of each structure depending on to its complexity. During this preliminary visit, the points that require special attention and the measurements to be taken can be listed in detail.

An inspection is not possible unless there is preferably a total closure or at least partial closure of the tunnel to traffic. The intervention periods must be established by taking into account any operating constraints on the road (high traffic periods, winter viability, scheduled projects, possibilities for diversion).

When the team in charge of the DI is designated, it must:

- ◆ schedule the intervention (request the intervention constraints from the organisational and operational services, etc.),
- ◆ recover the structure dossier (including the results of prior monitoring),
- ◆ analyse the dossier, especially the history of the structure, and certify that it has indeed read it,
- ◆ **prepare the background plans for the intrados surveys.**

The inspection manager, in liaison with the operational service, must produce an intervention programme. The programme must define:

- ◆ *the days and the time slots for the interventions,*
- ◆ *the human resources needed for the inspection team,*
- ◆ *the other human resources required (police assistance , colleagues from the operational service, etc.),*
- ◆ *the respective roles of all involved,*
- ◆ *the access points to be used,*
- ◆ *traffic management to set up the intervention if necessary,*
- ◆ *any traffic diversions to set up,*
- ◆ *the list of specific equipment (access platform/MEWP, forklift truck, etc.).*

10.2.4 In-situ intervention

For the intervention team, this includes:

- ◆ setting up the resources requested by the organisational service (access platform/MEWP.) and all of the equipment needed to conduct the inspection (see chapter 7),
- ◆ verification of the safety requirements for the intervention set out in the general coordination plan for safety and health protection (PGCSPS) or the "Special notice" drafted by the tunnel manager (see **appendix 3**),
- ◆ the close-up visual examination "within touching distance " of the parts that can be accessed as defined during the preliminary visit and the complete listing of the deteriorations supplemented by a few simple measurements (distances, lengths and openings of cracks, hammer soundings, samples, etc.),
- ◆ the inspection of the area of influence above the tunnels when cover is low to check, in particular, the proper management of vegetation, the integrity of any visible drainage or waterproofing devices, confirmation that loadings do not exceed those taken into account during the design of the structure, etc.,
- ◆ taking photographs that can assist in understanding the deteriorations and in illustrating them.

Where appropriate, the survey manager on the site must take the initiative to suggest to the tunnel manager any additional investigations that he deems necessary in order to interpret his observations. Afterwards the report should justify the validity of these investigations.

10.2.5 Assessment meeting

At the end of the visit, an assessment meeting should be held, on site, with the tunnel manager, during which the organisation in charge of the DI presents the main deteriorations observed. This assessment meeting is desirable in all cases; and it is essential when an area is likely to be rated 3, 3U or assigned the note S, i.e. when the maintenance or repair actions must be initiated immediately after the inspection.

10.2.6 Creating surveys of the deteriorations

The recording of deteriorations found by the intrados survey should be done using an unambiguous codification system which can be interpreted by any person that needs to consult it for the purposes of an intervention, regardless of its nature.

The design and the codification system for intrados surveys for tunnels is covered in **appendix 11**. The method presented consists of noting the observations on a developed plan of the arch as seen from the exterior of the structure, in order to obtain a detailed record of the intrados.

The person in charge of creating the surveys should use the nomenclature and symbols provided in the various catalogues of defects and recommendations published by CETU, SETRA or AFTES (see **appendix 11**).

10.2.7 Drafting of the detailed inspection report

A model report is provided in appendix 12. Where applicable, the tunnel manager can adapt this model to its structure or structures and attach it to the tender enquiries to companies (DCE) if it wants the service provider to comply with it.

In the event the DI of a tunnel in the national road network not under private management was carried out by a private design consultancy, the report must be checked externally by RST. Likewise, the suggestion of an IQOA-Tunnels rating must be subject to such an external control also.

As with the defect survey, the person in charge of drafting the report must use the nomenclature provided in the guidance published by AFTES, CETU or SETRA for the description of the parts of the structure, their names and the characteristics of the defects.

10.2.8 Conclusion meeting

The inspection report can be presented at a meeting organised with the tunnel manager. During this meeting the inspection manager must present the main results of the inspection followed by the suggested ratings. This meeting is desirable in all cases; and is essential when an area is likely to be rated 3 or 3U, or if its score is assigned the note S.

10.2.9 Example of application to a bored tunnel with a concrete lining

DETAILED INSPECTION OF THE TUNNEL

OF

XXX

Specific technical clauses (CCTP)

ARTICLE 1 – NATURE OF THE SERVICES

1.1 – Purpose of the contract

The purpose of the work defined in this contract is the detailed inspection of the tunnel of XXX, as defined in the Technical instruction for supervision and maintenance of engineering works (Instruction Technique pour la Surveillance et l'Entretien des Ouvrages d'Art (ITSEOA)) of December 2010. The particulars for the detailed inspection of a tunnel are provided in the technical guide "Tunnels – Civil engineering works and equipment" (Booklet 40)" and in the "Road tunnel civil engineering inspection guide", version 2013, published by the Centre d'Études des Tunnels (CETU).

The inspection is of the civil engineering works and covers all the parts mentioned in the description of the structure. It must undergo a close-up visual and auditive examination. For surface run off and drainage networks, it covers all their parts that can be accessed via access openings or the inspection chambers.

1.2 – Description of the structure

➤. *Provide the inspector with a detailed description of the structure*

1.3 – Content of the works

The detailed inspection should take place in four main phases:

- ◆ *preparation,*
- ◆ *the detailed inspection itself,*
- ◆ *an assessment meeting at the end of the inspection on site (with a summary report via fax or electronic mail),*
- ◆ *the agreement of the inspection report and the suggested rating according to the IQOA-Tunnels method, as well as a wrap-up meeting during which the conclusions of the inspection and the suggested ratings are presented.*

1.3.1 Preparation

This phase includes:

- ◆ *obtaining from the tunnel manager all the documents needed for the preparation and final analysis of the detailed inspection,*
 - ◆ *studying these documents,*
 - ◆ *establishing plans and baselines for surveys, required for the proper phasing of the inspection,*
 - ◆ *the preliminary visit to the structure which makes it possible to define the resources needed for the inspection,*
 - ◆ *the establishing of a quality plan (QP),*
 - ◆ *the establishing of a plan for safety and health protection (PPSPS),*
 - ◆ *procuring all necessary plant and equipment required by the inspection plan and obtaining the necessary road closure authorisations,*
 - ◆ *developing an intervention schedule with the tunnel manager (project owner).*
- *The preparation phase has to be agreed by the organisational level before any intervention in the field.*

1.3.2 Detailed inspection

The inspection is carried out in accordance with the ITSEOA and with any guidance mentioned in the scope of the contract. This is a visual and auditory inspection of all of the parts of structures and of areas of influence at the approaches:

- *List the elements to be inspected*

For the tunnel of XXX, the defects or faults able to be observed are those in the list provided in the CETU's "Road tunnel civil engineering inspection guide"; this is not a complete list.

For each type of fault, details on the parameters to be noted and the associated defects or faults to look for are provided in book 2 (Catalogue of defects) of the "Road tunnel civil engineering inspection guide".

The contract holder produces a survey plan on paper, comprising a baseline plan comprised of a developed drawing of the tunnel, at a scale of 1/100, or using any other process (computerised techniques) that provides the same level of precision.

The structural details of the tunnel, such as recesses, shafts, by-pass, as well as the equipment (accelerators, variable message signs) should be marked on the surveys so as to facilitate location.

In the event the inspection team identifies a major problem that threatens the short term stability of the tunnel or the safety of the users, it must immediately inform the organisational service (project owner) and at the same time forward a report to it.

1.3.3 Assessment meeting

At the end of the visit, a meeting should take place on site with the organisational service (project owner), during which the contractor presents the defects observed and how they have changed since the previous detailed inspection. The contractor also provides its preliminary comments on the defects and any changes in them.

1.3.4 Drafting of the inspection report

All the observations made during the inspection are logged in a report similar in format to the model provided in appendix 12 of the "Road tunnel civil engineering inspection guide".

[If the format adopted by the survey manager is different, it is recommended the DCE should be provided with a specimen of the inspection report with marked up to show how the minimum content required by the recommended format will be displayed.

The report supplements and interprets the intrados surveys by providing a description of the defects and an analysis of the deteriorations along with the reasons for their occurrence. It includes a conclusion on all of the observations made.

It sets out recommendations on the maintenance campaigns (routine or specialised) required. It lists the points to monitor and any instrumentation which should be installed as well as the additional investigations to be carried out, where applicable. It indicates the nature of the repair work that may need to be carried out.

It is illustrated with photographs and drawings order to facilitate the understanding of the faults and deteriorations.

The inspection report proposes an IQOA-Tunnels rating to the project owner (Quality image of engineering works) for the structure by area.

The codification of the defects found by the surveys must comply with the recommendations of Booklet 40 and the codification proposed in the "Road tunnel civil engineering inspection guide" published by the CETU.

The report, in its draft form, is sent within a period of XXX months from the initial visit. The project owner then has a period of two weeks to analyse it and comment on it.

[It is recommended to include in the contract document act of commitment, the CCAP or the CCTP the various timescales for submission of the "minutes", the post-survey meeting and the submission of the final report as well as the timeframe that the manager sets aside for reading and validating the service – for example, a period of 3 months can be required between the visit and the submission of the final report].

1.3.5 Presentation meeting

The inspection report is presented at a meeting organised with the organisational and operational services of the managing contracting party.

The report in a draft version must be forwarded to the organisational service at least 15 days before the meeting.

During this meeting, the survey contractor must:

- ◆ *comment on the report and its conclusions,*
- ◆ *explain the nature of the recommended maintenance or repairs,*
- ◆ *justify the proposed IQOA-Tunnels rating.*

The contractor also presents, during the meeting, any possible additional investigations required in order to better identify the deteriorations, their causes and how they can change. He describes the monitoring actions that he is recommending.

He identifies the degree of urgency for the maintenance or repair actions that he recommends be initiated to ensure the long term stability or the return to serviceability of the structure.

During this meeting, the proposed IQOA-Tunnels ratings must be discussed, especially the "Water" rating which has to be adjusted.

At the end of the meeting and once observation are received from the tunnel manager, the contract holder makes any necessary modifications and adjustments to the report and provides the contracting party with the final version in accordance with Article "2.6 Documents to submit" within a period of XXX weeks.

ARTICLE 2 – CONTENTS OF THE REPORT

2.1 – Data made available to the contract holder

As soon as the order is placed, the following information is sent or forwarded to the holder of the contract:

- ◆ *summary documents that present the structure, explaining the construction method, as well as plans and transverse profiles for the various sections,*
- ◆ *the previous detailed inspection report,*
- ◆ *reports on any additional investigations conducted since the last inspection.*

➤ *List to be extended or modified.*

The content of the structure dossier is provided in document X.X of the DCE. The contract holder can consult it or obtain copies including digital copies of all of the documents that can facilitate his inspection programme by contacting:

➤ *Contact information (address, tel., email of an identified correspondent)*

2.2 – Framework of the inspection report

The inspection report must cover all of the points indicated in the framework provided in appendix 12 in the "Road tunnel civil engineering inspection guide" published by CETU.

[If the format adopted by the survey manager is different, it must be indicated here " A model report and the minimum content that must be mentioned in it are provided in document X.X of the DCE."]

The presentation of the report (cover page, formatting, fonts, text styles, etc.) must comply with the graphics styles which along with an example, will be provided when the service is launched.

The report must be written in a clear and uncluttered manner, accompanied where needed with drawings and photographs.

Written documents (notices, documents explanations, tables, small drawings, etc.) can be provided in A4 format ("portrait" or "landscape") or possibly in A3 "landscape".

2.3 – Surveys of defects

Surveys must show all of the defects in and deteriorations with the tunnel, regardless of their nature and severity.

The tunnel manager provides the contractor with all the computerised files that it has on the tunnel, especially surveys *in AutoCad format (specify the version)* from the previous inspection. The contractor creates the missing plans. He supplements or modifies the plans that have errors. Creating the missing plans or adapting the existing plans for the execution of this contract are to be done at the expense of the contractor.

All surveys conducted on site are scanned into a computerised system, that can be used by the contracting party and the project owner (*compatible with AutoCad (specify the version) or any other software used by the contracting party*). The computerised system that can be used should allow for the distribution, production and any modification of the documents by the project owner.

Each type of defect or problem is included on its own plan, and is characterised by a colour. The final drawing is made up as a compilation of the various plans.

The computerised document, submitted by the contract holder, must allow for the separation into layers of the following :

- ◆ *stemming from each of the previous inspections, where this information can be supplied by the organisational service:*
 - ◆ *background plan: a true to scale drawing of the structure ,*
 - ◆ *Text boxes: it includes the text used to define the structure and relating to the observations made during previous inspections (one layer for each inspection date),*
 - ◆ *Details of for longitudinal cracks (separate details layer for each inspection date),*
 - ◆ *Details of transverse cracks (separate details for each inspection date),*
 - ◆ *Details of inclined cracks (separate details for each inspection date),*
 - ◆ *Details of unstable areas (separate details for each inspection date),*
 - ◆ *Details of purged areas (separate details for each inspection date),*
 - ◆ *Details of hollow sounding areas (separate details for each inspection date),*
 - ◆ *plans for zones presenting other types of deteriorations (concretions, patches, cavities, gravel pockets, etc.) (separate details for each inspection date and each type of problem).*

➤ *List to be completed.*

- ◆ *Arising from the detailed inspection, the purpose of this contract:*
 - ◆ *Text boxes: it includes the texts relating to various observations made during the inspection,*
 - ◆ *Details of new longitudinal cracks,*
 - ◆ *Details of new transverse cracks,*
 - ◆ *Details of new inclined cracks,*
 - ◆ *Details of new unstable areas,*
 - ◆ *Details of new purged areas,*
 - ◆ *Details of new hollow sounding areas,*
 - ◆ *Details of new areas having other types of deteriorations (separate details for each type of problem),*

➤ *List to be completed.*

The faults or deteriorations noted during previous inspections will be on different layers but with the same grey colour (preferably).

The codification of the deteriorations complies with that defined in the "Road tunnel civil engineering inspection guide" published by the CETU.

2.4 – Photographic illustrations

The report includes photographs of parts inspected and the structure portals as well as detailed photographs where these are required to better understand the observations made.

These are placed in the report across from the corresponding observations. A numbering system and a key must make it possible to cross reference relate a photograph in the report with the corresponding indicator on the surveys and vice-versa. The detailed photographs should incorporate a scale mark in the image.

The original photographs will be submitted in computerised format at the end of the contract. The photographs incorporated into the report or on the survey plans can be cropped if necessary but in any case should be resized to the maximum format of 640x480 pixels.

2.5 – IQOA-Tunnels rating

The evaluation and the proposal of an IQOA-Tunnels rating of the areas are submitted with the report in the form of an IQOA-Tunnels rating sheet for the civil engineering works for which an example is provided in appendix 13 of the "Road tunnel civil engineering inspection guide" published by the CETU.

2.6 – Documents to be submitted

Four copies of the intrados surveys and inspection reports are to be submitted : 3 on paper format and one on a computerised format.

The scales must be identical for all the surveys. The scale for plans printed on paper is 1/100. The plans are presented either in the form of A3 or A4 notebooks, or in the form of A0 drawings folded into A4 format.

It is requested, that for the entire tunnel, all the data for the report (text, tables, drawings, plans, surveys and photographs) should be gathered together into a single read-only file (file extension: .pdf).

All the data has also to be recorded separately for later use. The surveys for the deteriorations should be attached in "pdf" and "dwg" format (*AutoCad version to be specified*). The report should be saved in a format that can be used with the software suites *OpenOffice* or *Microsoft Office*. The images should be in JPEG format (extensions .jpg or .jpeg).

All of the data should be placed on a CD or a DVD.

ARTICLE 3 – CONDITIONS FOR CARRYING OUT THE INSPECTION

3.1 – Intervention schedule

The intervention schedule, including phasing, diversions and stoppages of traffic (operating file for the site) is established by the contractor and submitted for approval to the operational service. The intervention schedule must comply with the operating constraints. The supply, installation and removal of adequate signs are at the expense of the contractor.

The operational service, taking account of operating constraints, can agree to suspend and even postpone certain interventions. In any case, the nature of the defects, their causes and the solutions considered are logged in the intervention log.

If the extent of the site extends into the neighbouring lanes, the contractor must, in coordination with the managers involved, obtain at his expense all the necessary permissions, as well as the supply, installation and removal of adequate signs.

The temporary signs must comply with current regulations (8th part of the Interministerial instruction on road safety (IISR)) and the drawings of the operating dossier for the site (DESC) must be established using the recommendations of the technical guides "Temporary signs" (volumes 1 to 8) published by SETRA.

➤ *The appropriate changes must be made if the operating file for the site, the steps necessary to obtain the lane closures and the signs for the site are handled by the management of the tunnel.*

3.2 – Operating and creation constraints

➤ Specify here the time slots that allow for work, the traffic conditions (complete closure, lane closures), the conditions for accessing the ducts, the timeframes for removal, etc.

The contractor must, in accordance with the operating constraints, adapt and justify the observation techniques that it intends to use. The price for the contract includes any inconvenience due to operating constraints (*work at night, work with alternating traffic, lighting adapted to the intervention conditions, etc.*).

The manager can at any time order the immediate cancellation or temporary interruption to the inspection on site in the following cases: accident in the tunnel, fire in the tunnel, abnormal weather conditions, manoeuvres or unexpected exercises, abnormal traffic volumes (*indemnities to be specified*).

Any visit to the site by people who are not part of the inspection team is subject to approval from the project owner.

The representatives of the project owner and of the manager can become members of the contractor's inspection team and follow their movements.

3.3 – Access to the site

The contractor must comply with the safety rules defined in the general coordination plan in terms of safety and health protection (PGCSPS) (*or of the "Special notice"*) and specified in its special plan in terms of safety and health protection (PPSPS). It must, in addition, follow any instructions of the manager given before the intervention starts.

The contractor must also comply with any instructions on safety or data organisation given by the managers of the other public areas affected by the inspection work. It must forward a copy of these instructions to the project owner before any intervention.

3.4 – Intervention log

The contractor completes an intervention log in which the following are recorded:

- ◆ *The staff and equipment resources in place,*
- ◆ *the weather,*
- ◆ *the areas inspected,*
- ◆ *the various deteriorations encountered,*
- ◆ *new instructions from the organisational service if any,*
- ◆ **new constraints arising from the work if an.**

➤ *This log must be appropriate to the tunnel being inspected. A site log should be requested for any long tunnel that takes more than one week to inspect or for a tunnel that has substantial constraints on intervention.*

ARTICLE 4 – PERSONNEL

➤ *The minimum qualifications for the personnel undertaking work under the contract should be appropriate for the phase of the contract being undertaken.*

4.1 – Qualification

Personnel must have received skills training in inspecting structures and must have at least the following qualifications:

- ◆ for an inspection agent or assistant:
 - ◆ knowledge of civil engineering and one year's experience in inspection ;
- ◆ for an inspector or person in charge of studies:
 - ◆ holder of a level IV equivalent degree (baccalaureate certificate): three years of experience in inspection along with knowledge of civil engineering, geotechnical engineering and fault development in engineering works,
 - ◆ holder of a level III degree (BTS (vocational training certificate), DUT (university technology degree, etc.) in the field of civil engineering: one year of experience as well as knowledge of geotechnical engineering and fault development in engineering works;

- ◆ for the manager of the on-site survey team:
 - ◆ holder of a level III degree (BTS (vocational training certificate), DUT (university technology degree, etc.) in the field of civil engineering: three years of experience in inspection as well as knowledge in geotechnical engineering and fault development in engineering works;
 - ◆ holder of an engineering degree in the field of civil engineering: one year of experience in inspection as well as knowledge in geotechnical engineering and fault development in engineering works;
- ◆ for the inspection manager:
 - ◆ holder of an engineering degree in the field of civil engineering: one year of experience in inspection as well as knowledge in geotechnical engineering and fault development in engineering works.

➤ *In the case of unlined tunnels or when the geology of the area of influence demonstrates factors or deteriorations that are relevant to the tunnel, a person who is a geologist or has had training in geology should be included in the list of personnel.*

4.2 – Overall provision of service

The detailed inspection must be conducted by a qualified engineer who must have received specialised training. This person is responsible for representing the contractor with the organisational service and, as such, can sign any document relevant to the contract.

He manages the drafting of the report. He is responsible for the analyses and the conclusions contained in it.

The name of this person, and of those responsible for each of the subsequent phases, should be given to the project owner before the beginning of the first phase. Any subsequent change in personnel must be submitted for approval to the project owner.

The contractor must justify the experience and skills of his personnel. To this effect, he must provide the curriculum vitae for the members of the inspection team who will actually be doing the field work and for the inspection manager.

4.3 – Preparing the inspection

For this phase, the contractor forms a team comprised of at least the inspection manager, the manager of the on-site survey team (study of the existing documents on the structure, analyses of previous inspections, participation in the preliminary visit) and an assistant (preparation of the background plans).

4.4 – Detailed on-site inspection and assessment meeting

For this phase, the contractor forms a team comprised of at least the manager of the on-site survey team, a second inspector and an inspection assistant (for the hammer surveys and for driving the vehicles, etc.).

4.5 – Drafting of the inspection report

For this phase, the contract holder forms a team comprised of at least the inspection manager (summary and validation of the report) and of the manager of the on-site survey team (drafting of the report).

The report is checked by the project owner. In case of error, the contractor is responsible for correcting any errors.

4.6 – Presentation meeting

For this meeting, the contractor is represented at least by the inspection manager (filing the report, proposal of the IQOA rating) and the manager of the on-site survey team.

ARTICLE 5 – EQUIPMENT

The contractor provides the equipment needed to carry out the inspection. The contract takes into account the mobilisation and demobilisation of all the resources, products and tools needed to properly carry out the inspection.

In particular, the contractor is in charge of providing all the access equipment (MEWP , etc.) required to get within one metre or less from the tunnel's lining (inspectors need to have their "hands on" the structure). The means for lighting must allow for an adequate view of the structure from all directions, in the bores as well as in drainage ducts etc.

The choice of equipment should be submitted for approval to the project owner and must take into account any constraints linked to the operation of the tunnel, safety deteriorations identified during the preliminary visit and any disruption to traffic caused.

➤ *To be adapted to meet the particular intervention conditions in the tunnel*

The equipment used by the contractor must be used in accordance with the manufacturer's specifications and recognised safety guidelines. They must be adapted to the particular working conditions in the tunnel.

Statutory inspections of access equipment should be undertaken as necessary at the contractor's expense. In the event of inappropriate equipment being provided or some equipment not being declared safe then the use of such equipment is prohibited.

In case of uncertainty as to compliance with safety requirements, the project owner should take whatever steps he considers appropriate necessary. In such circumstances the contractor is responsible for all costs arising from defective equipment.

Vehicle drivers and operators must be trained and hold all relevant certificates and authorisations required to use them (legal driving permits, driving authorisations, etc.).

The electrical tools used are of Class II with 30 mA protection.

Ladders and stepladders are prohibited for the inspection (*except for one-off access to recesses, the upper levels of certain evacuation galleries, one-off measurements of crack gauges, etc.*).

All intervention personnel should be provided with personal protective equipment and a Class 2 yellow-colour high visibility vest (compliant with standard NF EN 471).

Any parts protruding from the sides of vehicles operating on site are marked with retro-reflective red and white strips. Vehicles present on the inspection site, that are servicing it or that are parked at the edge of the road, should bear a reflective Class 2 "maintenance" plate. The vehicles must be equipped with special lights provided for in Article 122 (paragraph C) of the 8th part of the IISR of November 2008.

➤ *The elements below are to be incorporated into this document and are to be adapted as appropriate:*

For inspecting ventilation plants, the contractor must provide the additional personnel and material resources for work at height.

The interventions in technical ducts, in ventilation ducts or in confined spaces can only be carried out after locating all the networks. Those intervening must be equipped with an oxygen detector and carbon monoxide detector (CO) with audible alarm, in order to prevent the risks of suffocation.

Ventilation shafts should be inspected by duly authorised rope access technicians provided with suitable personal protective equipment. The interventions should be conducted by at least two people (one rope access technician for the inspection in the shaft and the second outside but in constant radio contact. The ropes should be examined in detail before the intervention. The rope access technician inspecting the shaft is, in addition, provided with a cap lamp and a protective mask for any unexpected updraft of fume. For intervention in electrical premises, personnel must meet statutory requirements.

For intervention in electrical premises, personnel must meet statutory requirements.

ARTICLE 6 – QUALITY

➤ *the contracting party's requirements in terms of quality assurance can be adapted to the size of the structure or structures to be inspected.*

The quality plan (QP) comprehensively specifies, before the work commences and for all particular points, the methods and the procedures to be implemented in order to obtain the required quality. This is liable to be changed during the survey period.

6.1 – Drafting of a quality plan (QP)

The quality plan indicates the methods and the procedures to be implemented by the service provider for the correct execution of the survey with which it has been entrusted.

The QP is based on the recommendations and the specifications of this CCTP and the texts that are referenced in it (standards, instructions, technical guides). It specifies the requirements for carrying out the internal control procedures set up in the company, the constraints resulting from external controls and in particular the milestones (or steps) that require formal approval from the project owner before continuing with the project.

The QP is established by the contract holder and is submitted for approval to the project owner during the preparatory period and no later than XXX days before the scheduled date of commencement on site. It can be revised and supplemented during the course of the contract, in order to take account of changes in it.

➤ *The timeframe granted to the contract holder for drawing up the quality plan must be set down in the CCTP and included in the CCAP or vice-versa.*

The additions to the QP developed during the project are submitted for approval by the project owner in accordance with the same conditions as the initial version.

6.2 – Composition of the quality plan

The quality plan includes the following information:

- ◆ *reminder of the work entrusted to the contract holder (tunnel involved, place of execution, summary description of the structure and of the various parts to be inspected, etc.);*
- ◆ *reminder of the various people involved: project ownership (decisional, organisational and operational levels), project management, external control, H&S coordinator where applicable, any subcontractors, etc. ;*
- ◆ *the general organisation of the contractor and the organisation chart specifically set up for the work: names, CVs, qualifications of the inspection manager, of the on-site survey manager and of the various inspectors;*
- ◆ *the particulars for the internal control set up in the company, the circulation and the transmission timescales for the various documents to be established under the contract.*

The quality plan also provides details on the material resources that the contractor has and those that will be allocated to the project as well as the methods for executing the various steps in the inspection process.

6.3 – Stages of the work to be described in the quality plan

The various stages that require a method statement in the quality plan are:

- ◆ *preparation for the inspection: collection and analysis of the existing documents, establishing the operating file, preparing supports, etc.*
- ◆ *on-site inspection: phasing for the visit, parts with traffic or not, coordination of the teams, management for time travelled, switchover and breaks, etc.*
- ◆ *inspection report: interface between the on-site observations, analysis and interpretation in the office, forwarding to the manager.*

The method statements mention the type of internal control provided (internal, external) with the results to be obtained. They will be supplemented by the project owner with information on the external control.

Each procedure defines the milestones submitted for approval to the project owner.

6.4 – External control

The external control of the project owner consists of:

- ◆ *verifying compliance with the company quality plan and in particular the relevance of the internal controls.*
- ◆ *validating the milestones before continuing with the work,*
- ◆ *assisting the contracting party for the accepting of the documents issued by the contract holder*

The contract holder must comply with the timescales for intervention and analysis of the external control and comply with the lifting of the milestones before executing the corresponding services.

These controls do not relieve the contract holder from meeting its internal control procedures. In the event of failure, the project owner calls in its external control, after a formal notice has gone unheeded. The resulting costs are at the expense of the contract holder.

The external control for the mission is provided by XXX. *[If the project owner itself does not perform the external control for the mission].*

For the execution of the external control, the project owner is assisted by XXX *[If the project owner itself partially carries out the external control for the mission.]*

➤ *for the tunnels in the national network not under private management, inspections that are not conducted by the CETU have to undergo external control via the establishment of the Scientific and technical network of the ministry in charge of road infrastructures.*

On request from the project owner, the contract holder for the project can be subjected to an audit conducted by the external party which consists of a review of the quality system documentation and of its application, the verification of the methods and materials used for the inspections, the control and the analysis of the documents issued (in particular, the detailed inspection report, IQOA-Tunnels rating) and, possibly, on-site visits.

➤ *The audit is a complex procedure which is reserved for holders of major or multi-year inspection contracts.*

10.3 Appendix 3: Safety conditions to be complied with during scheduled monitoring and maintenance actions – Specific difficulties for intervention

Note: this appendix includes appendix 1, with regards to interventions in bored tunnels, of Booklet 40 "Tunnels – Civil engineering works and equipment" from October 2012.

10.3.1 Foreword

In accordance with decree 94-1159 of 26 December 1994, the organisational level or the operational level provides the companies or organisations represented on an inspection site with a general coordination plan for safety and health protection (PGCSPS). Its purpose is to define the safety measures that the companies must rigorously comply with during their work and their travel, in order to prevent the risks of accidents. Each company must, in turn, establish a specific plan in terms of safety and health protection (PPSPS) that adapts the principles in the PGCSPS to the nature of the work that it is undertaking.

The purpose of the PPSPS is to define the essential measures that the company must take in order to ensure the safety of its own personnel, as well as that of the users of the lane involved and of the persons who are not normally permanently on the site but who are authorised to access it. The document also concerns the measures for keeping the equipment, vehicles and installations used over the entire extent of the site in good working condition and properly maintained.

In the event the PGCSPS is not mandatory, it is recommended that the organisation in charge of operating the road establish a "Special Notice" that includes at least:

- ◆ the identification of the risks (especially the a drawing showing deteriorations concerning visibility),
- ◆ the precautions to take for managing the exposure to gaseous pollution and dust,
- ◆ the lighting conditions,
- ◆ the management of the liaison between the various contractors on site and the public,
- ◆ instructions for intervention.

10.3.2 Risks of accidents in the workplace – Regulations

In addition to proper observation of the French Labour Code and that of Social Security, companies or organisations that intervene on projects on tunnel sites must comply with the special regulations in place in order to prevent the risks of accidents.

The provisions to be complied with and the general legal provisions on hygiene and safety that these regulations set out govern are listed in appendix 7 of Booklet 2 "General points on monitoring" from the ITSEOA.

These regulations are updated by a permanent "safety and working conditions" guide that is constantly updated.

These rules concern only scheduled interventions, in relation to monitoring and routine maintenance. Emergency situations are governed by their own regulations.

10.3.3 Special provisions – Safety measures

Interventions in tunnels

Interventions in tunnels generally entail dangers that are greater than those when working in the open air, due to their nature as well as the reduced levels of lighting, the presence of shaded areas that reduce visibility, humidity that makes surfaces slippery, the narrow width making manoeuvres more difficult, pollution, etc.

All suitable measures to avoid these must be taken in a timely manner. The service in charge of operating the lane must always check to see if traffic flow can be maintained with complete safety, in light of the nature of the work and any repercussions of the work on drivers as well as on the workforce.

During periodic inspections, for reasons of health and safety, it is highly recommended that the tunnel bore being inspected be entirely closed to traffic.

Beyond the regulatory measures concerning the temporary signs required by the sites, the following additional measures are to be taken:

- ◆ fixed lighting of the tunnel (when it exists): turned up to the maximum during the entire duration of the work and throughout the entire length of the structure, except where the structure is several kilometres long,
- ◆ over the extent of the job site itself: general lighting which is sufficiently strong to view the arch and, if it is not closed to traffic, helps draw the attention of drivers as they approach the works,
- ◆ temporary road signs and position indicators: even in tunnels provided with fixed lighting, the regulatory signs and panels, which are normally reflective, must be lit or provided with synchronised flashing lights.

Note that in terms of marking, it is prohibited to begin the marking of a lane closure inside a tunnel. Advance warning and the locations of tapers for the lane closure must be located outside the tunnel.

The service in charge of operating the lane must consider the imposition a lower speed limit than in the open air depending on the nature of the work, the lighting and the signing conditions possible in the tunnel.

The control measures to counter pollution produced by the various site vehicles, and provided for in the PPSPS, must in principle be adequate to protect occasional visitors to the tunnel as well as those working in the tunnel.

However, in the case of alternating traffic where vehicles become stationary in the tunnel, the service in charge of operating the lane ensures that road users as well as personnel working in the tunnel are not adversely affected the discharge of pollutants from the site itself or from normal traffic.

It is desirable that the site vehicles used to carry out the inspections be equipped with an effective device for purifying exhaust gases (catalytic convertors, particulate filtration).

Finally, the electrical tools used are of Class II with 30 mA protection.

Interventions in ducts and in ventilation shafts

Interventions in technical ducts and ventilation ducts can only be carried out after identifying the entire networks. Those intervening must be equipped with a CO, oxygen detector with audible alarm, in order to prevent the risks of suffocation.

As inspecting these confined spaces can take a very long time, they must be carried out when there is no traffic in the tunnel and only after forced ventilation of the ducts has been carried out for several minutes in order to purge the atmosphere.

Ventilation shafts are inspected by authorised rope access technicians provided with suitable personal protective equipment (PPE). The interventions are conducted by two people together (one rope access technician for the inspection and the second outside) in constant radio contact. The ropes should be examined in detail before the intervention.

The rope access technician is, in addition, provided with a capamp and a protective mask for any unexpected discharge of fume or smoke.

10.3.4 Typical prevention plan

Type of operation:
Place of operation:
Scheduled dates: start and end of the works.....

CONTRACTING PARTY
Name:
Address:
Tel.:

EXTERNAL COMPANY
Company name:
Address:
Date of the order:
Type of works:
Place of intervention:
Scheduled date for the start of the work:
Scheduled date for the end of the work:
Name and qualification of the person responsible for the work:
Number of people working on the site:

LIST OF STATIONS THAT REQUIRE SPECIAL MEDICAL MONITORING
.....
.....

ORGANISATION OF FIRST AID
.....
.....

SAFETY INSTRUCTIONS TO BE COMPLIED WITH ON THE WORK SITE
.....
.....

METHODS FOR INFORMING THE EMPLOYEES WORKING ON THE SITE BY THE WORK MANAGER
.....
.....

10.3.5 Risks and means for preventing them

Definition of risks	Means of prevention
Impact by vehicles	<ul style="list-style-type: none"> • Provide all of the company's vehicles with marking at the rear, with retro-reflective strips, orange flashing lights • Wear personal protective equipment (clothing in accordance with the standards in effect) • Set up the temporary signs • Have the operator turn up the lighting as high as possible in the tunnel
Injuries caused by the rupture of existing services (water, gas, electricity)	<ul style="list-style-type: none"> • Locate the existing networks • Display the indications "Do not touch" or "Do not move"
Suffocation, smoke	<ul style="list-style-type: none"> • CO detector, oxygen detector • Ventilate • Use protective masks with filters
Noise	<ul style="list-style-type: none"> • Wear hearing protection
Falls from heights	<ul style="list-style-type: none"> • Use certified equipment (elevating aerial platforms or scaffolding) with personnel that have a competence certificate (CACES) that corresponds to the equipment used • For equipment use only operators authorised by their employer • Wear a safety harness
Incidents during operations in shafts, ducts or any other location difficult to access.	<ul style="list-style-type: none"> • Work in pairs with: <ul style="list-style-type: none"> - in the case of vertical shafts, one rope access technician for the inspection, the second outside the shaft - constant radio contact - inspect harness before use - a safety rope
Unintended start up of the ventilation during an operation in the ventilation ducts	<ul style="list-style-type: none"> • Ensure the automatic ventilation control devices have been turned off by the operator
Electrocution or electric shock	<ul style="list-style-type: none"> • Use a Class II device with protection for 30 mA • Comply with the safety measures relating to work in the vicinity of electrical installations (power down and comply with the safety distances)
Lighting cut-off	<ul style="list-style-type: none"> • Use an emergency light or caplamp

10.4 Appendix 4: Characteristic transverse profiles over time

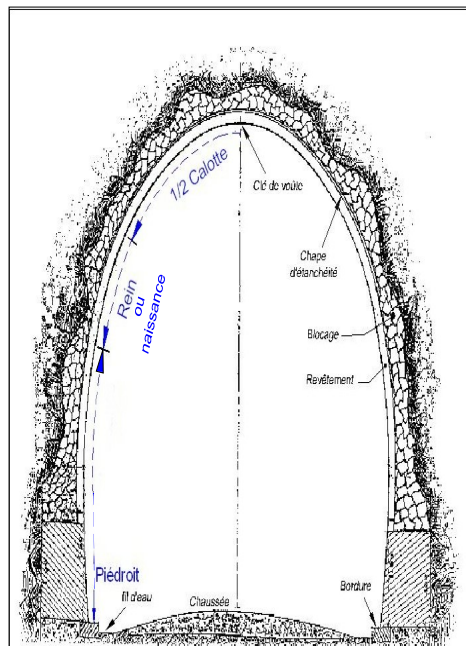

Figure 1: Vertical semi-elliptical arch (Lioran, 1847)

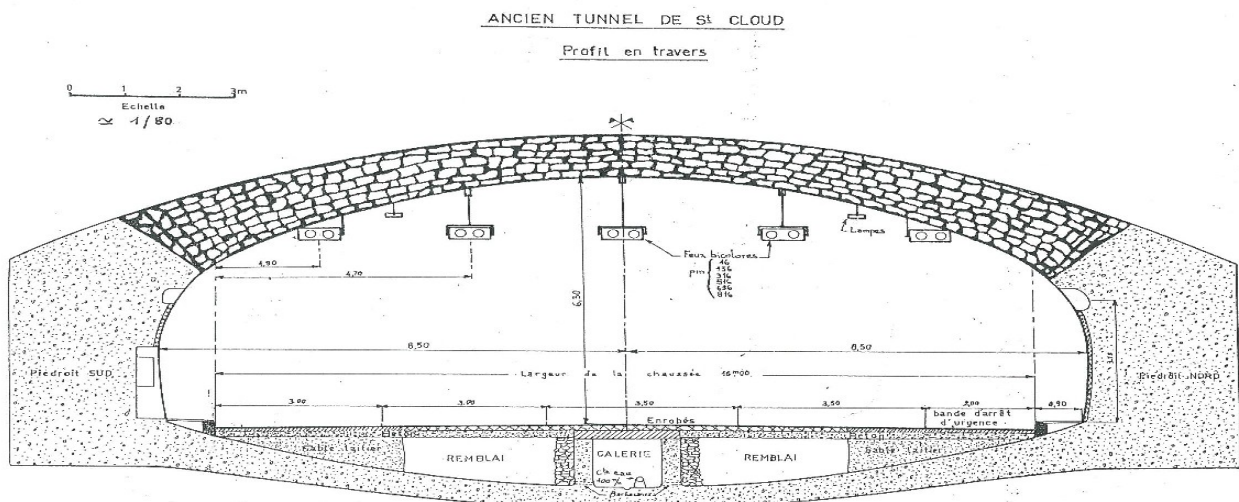

Figure 2: flat long span arch (Saint-Cloud, 1941)

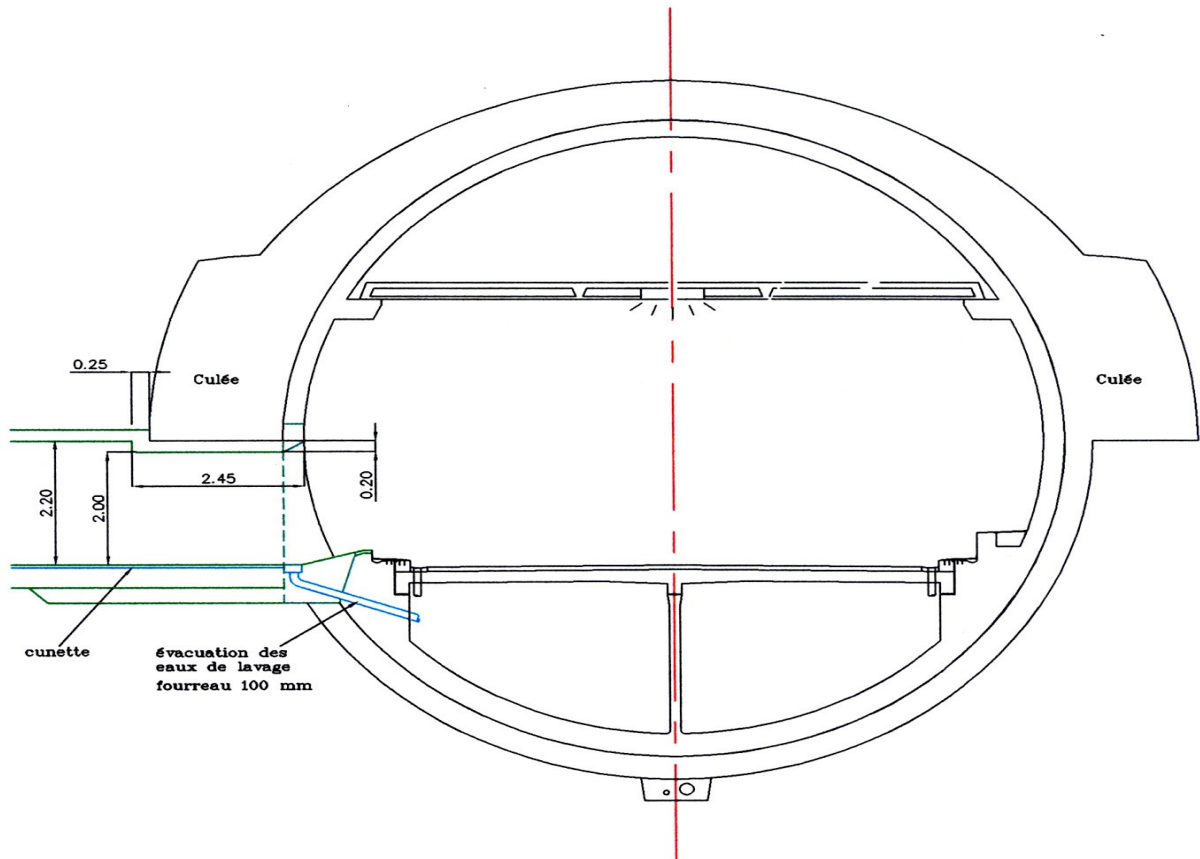

Figure 3: twin road deck, circular double arch (Lyon-Fourvière, 1971)

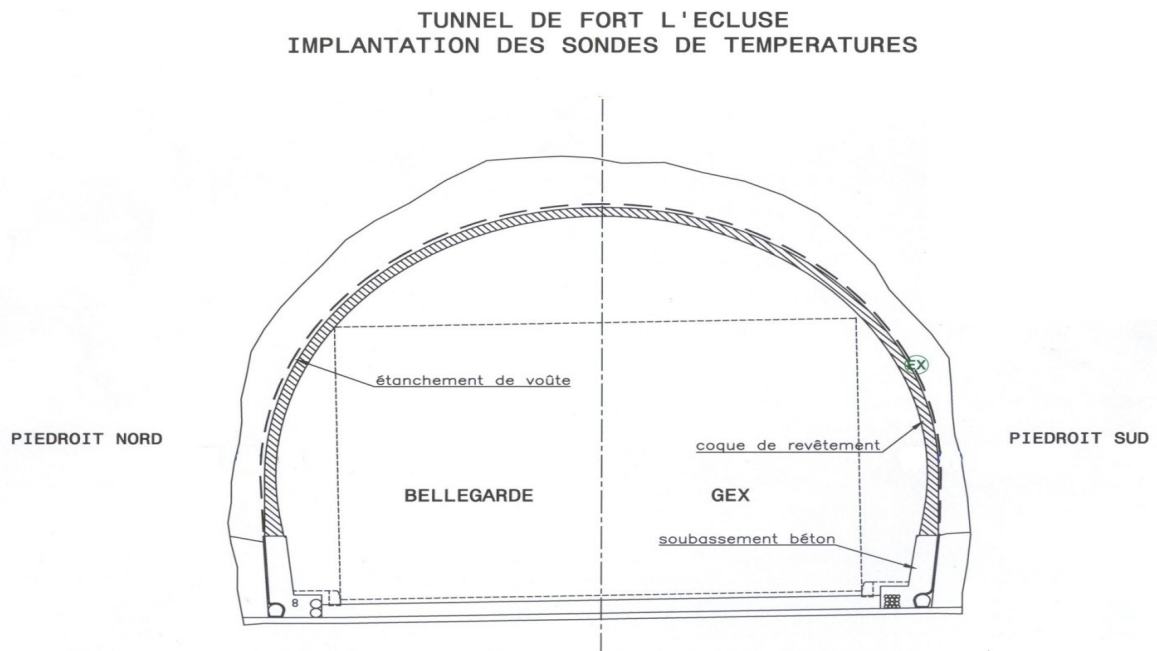

Figure 4: self-supporting arch, secondary lining only (Fort l'Ecluse, 1994)

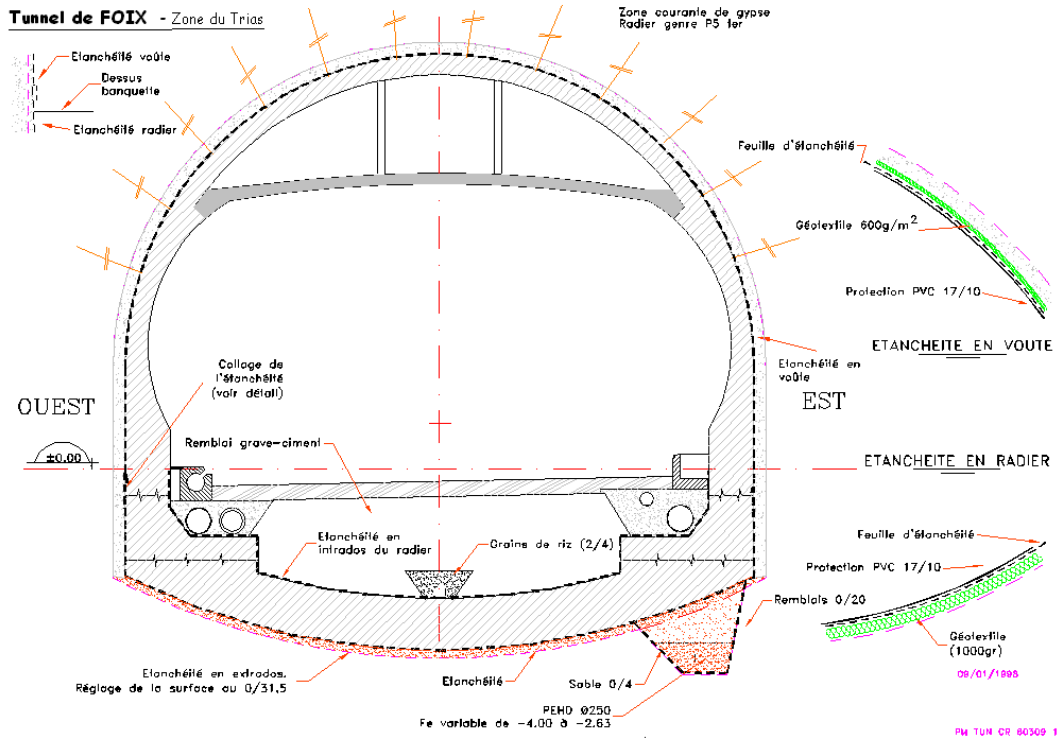

Figure 5: arch and counter-arch (Foix, 1999)

TUNNEL DE CALUIRE
= COUPE TYPE =
PM 0 à PM 3050

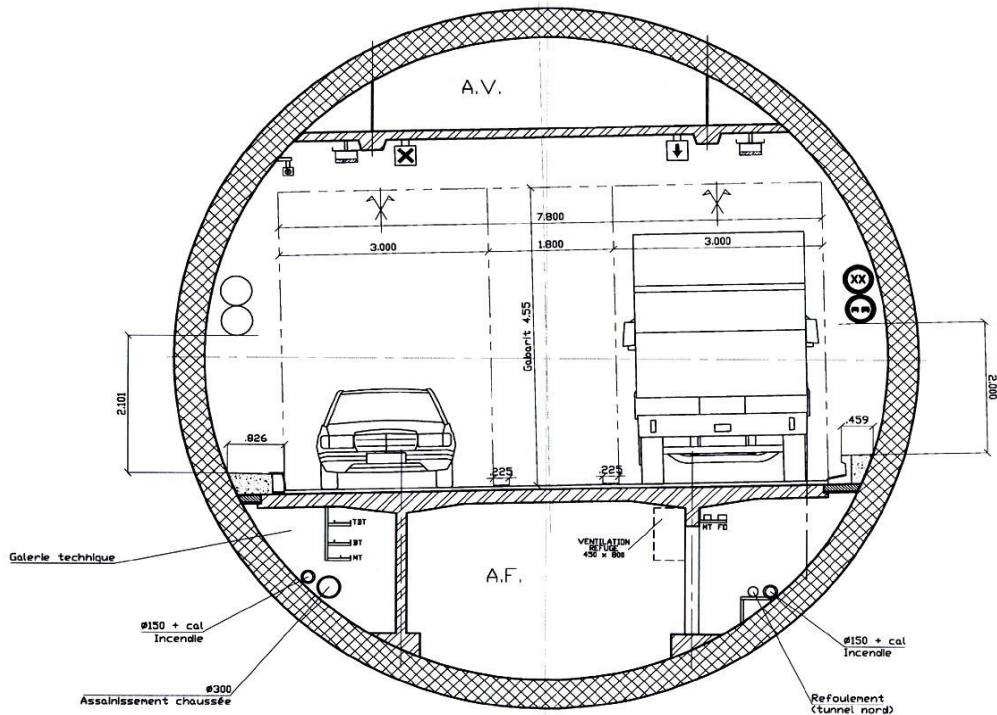

Figure 6: circular arch bored with a tunnel boring machine (Caluire, 1999)

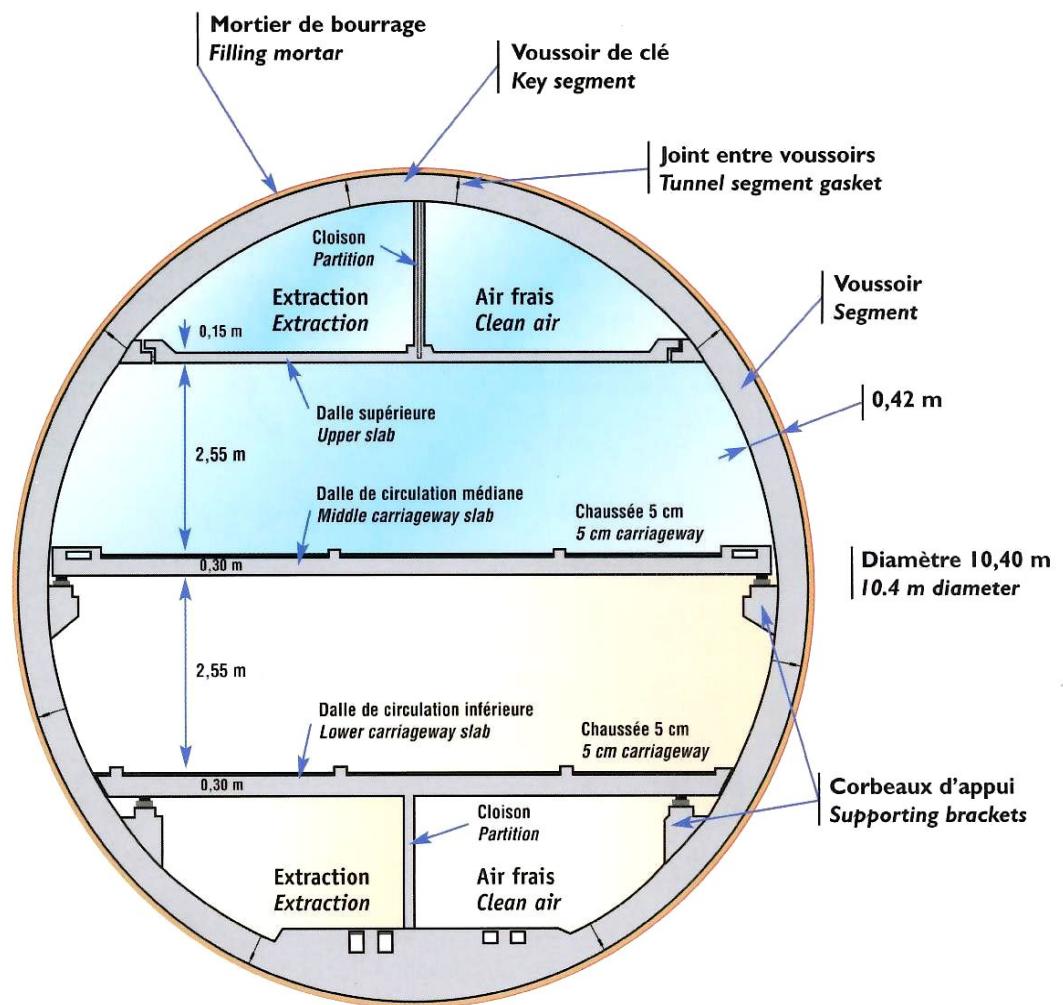

Figure 7: tunnel with multiple carriageways (A86 west, 2009-2011)

10.5 Appendix 5: Operation of a tunnel lining

10.5.1 Specifics with tunnel linings

Most tunnel linings "support":

- ◆ their own weight,
- ◆ loads resulting from interaction between lining and the ground (depending on the quality of the contact interface),
- ◆ the effect of the hydrostatic pressure from ground water on the extrados,
- ◆ thermal stress and shrinkage (concrete),
- ◆ operating loads (often low: equipment, vibrations...),
- ◆ accidental loads.

Tunnel arches operate very well, as long as their support from the surrounding ground is effective. In this case, the compressive effects pass through the central portion of the lining section coating and maintain the structure in compression.

This ideal condition may not be achieved at all points around the lining, which then gives rise to deteriorations. Tunnel therefore must be distinguished according to their lining.

Old masonry tunnels

Despite the absence of support structures prior to excavation, masonry has long shown its ability to adapt to variations in loads. It alone forms the final support structure. The presence of mortar joints provides flexibility that allows for what is sometimes substantial deformation which allows the forces to be redistributed in the lining. All of the lining, which was monolithic at the time of construction, is broken down into panels that rotate around "pinned joints". It is on the latter that we find specific deteriorations (scaling of masonry, opening of bed joints).

The space between the extrados of the lining and the rock, which is theoretically filled with rubble bound with mortar or dry-stone, often shows voids (at the roof section) or open jointed blockwork. The poorly distributed load transfer is an aggravating factor in the strength of masonry.

Modern tunnels with un-reinforced cast concrete

Normally, there are virtually no voids around the extrados of the lining; in addition the lining is in contact with the support structure of the excavation which already plays its role of confinement for the land. The loads are therefore (because of construction) more uniformly distributed around the interface between the lining and the ground than for a masonry lining.

However, in the case of substantial ground stress, the concrete lining, which is much more rigid than masonry, can fracture suddenly. In any case, these deteriorations exhibit early warning signs, which are sometimes discrete, that one must know how to detect.

10.5.2 Situations that generate deteriorations

"Fatigue" of the surrounding ground, squeezing ground generates stress and deformation in the structure. Due to the absence of "perfect" confinement in old structures and therefore due to a non-homogeneous distribution of stresses, their lining is often subjected to one-off loads.

On the other hand, with regard to recently-built structures, the distribution of ground loading is more homogeneous but the lining is less tolerant of these deformations.

A problem appears if the limit of permissible deformation of the material, or its permissible stress limits, are exceeded. The following two theoretical diagrams illustrate the deteriorations.

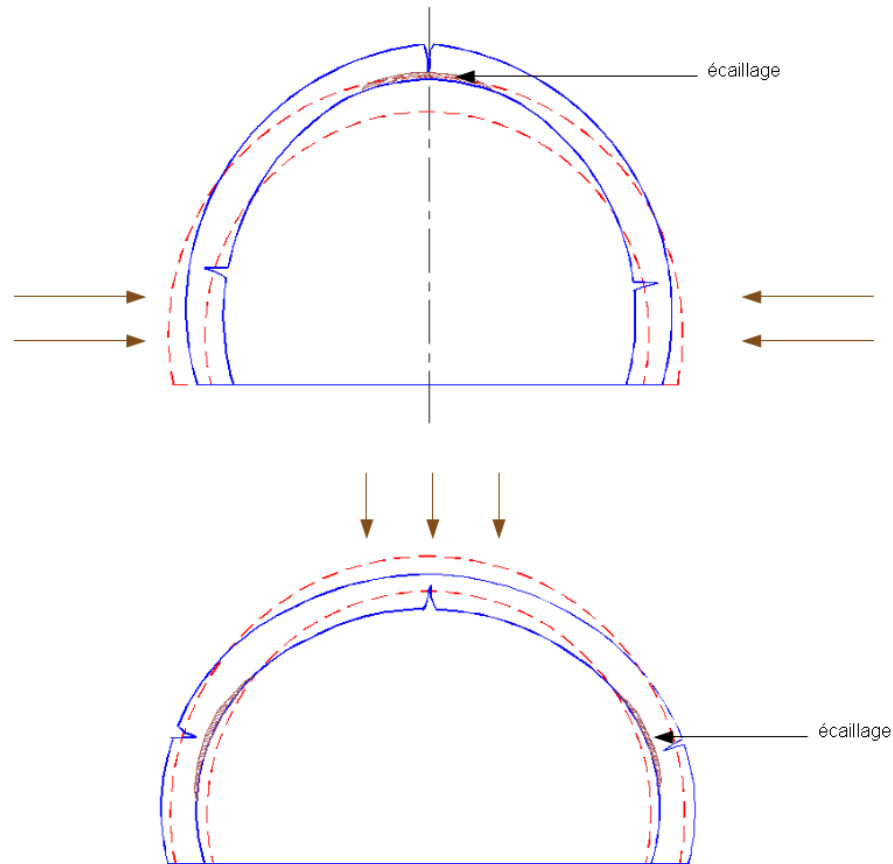

*Figures 1a and 1b: typical deformations of the lining under the stress of the surrounding ground
(dotted line: **theoretical profile**, solid line: **deformed profile**)*

The areas of the intrados in compression manifest themselves by mechanical spalling. The areas in tension will manifest themselves through open joints or cracks. In practice, the deformation of an arch is rarely symmetrical. The two types of deformation often occur together and asymmetrically; these can be discovered at any point of the profile.

10.5.3 Measurements

The examination and the categorisation of the deteriorations with the lining must be supplemented with:

- ◆ relative convergence measurements: the cross-sectional dimensions of the profile of the affected section are measured periodically in order to get information on the absolute deformation and the rate of change of the deformation (which can be several mm/year for old tunnels);
- ◆ stress measurements (with a pressure cell or via overcoring) make it possible to know the values of the compressive stresses at different points of the lining;
- ◆ measurement and control of the effective thickness of the lining (by coring or by drilling and using an endoscope).

10.6 Appendix 6: Analysis and characterisations of materials

10.6.1 Analysis of water

Water is one of the main sources of deteriorations. In the event of inflow of water into the structure, we begin by looking for possible external sources: water table, rain, seepage and surface infiltration, leaks from buried pipelines, etc. to see if remedial actions can be considered by utility owners.

If the inspector can assess the instantaneous flow rate on the day of his visit, measurements of the flow rate should be taken on a regular basis over a period of time. Their variations can lead to identification of a possible origin of the source, for example if the amount of rain is also measured or obtained from the weather services.

A physical-chemical analysis can make it possible to determine the source of the water. This analysis is also indispensable in assessing the possible harmful effects of the water on the structure or on its equipment: chemical attacks on concrete and mortar, corrosion of reinforcement, clogging of the drainage system, etc.

The inspector himself, using simple devices, can measure certain parameters such as flow rates, temperature, acidity/alkalinity (pH), conductivity which will provide a preliminary idea of the possible or likely origin of the water.

In parallel, samples can be taken and analyses of water can be conducted by a specialist laboratory. These analyses can allow an assessment of how "aggressive" the water is or of its potential to lead to carbonate deposition. Tests include a determination of:

- ◆ the pH (if possible on site),
- ◆ total alkali content (TAC); expressed in French degrees (°f), it is used to measure the hydroxide, carbonate and bicarbonate content in water,
- ◆ the calcium content (Ca^{++}),
- ◆ dissolved salts (dry matter at 105 °C),
- ◆ the aggressiveness of the water: measured by the Langelier-Hoover index or by the Riznar index, it indicates the ability of the water to dissolve or to deposit calcium carbonate .

If a particular chemical attack is suspected, the analyses must be supplemented by measurement of:

- ◆ chlorides (Cl^-)
- ◆ sulphides (S^-)
- ◆ sulphates (SO_4^{--})
- ◆ magnesium (Mg^{++})
- ◆ total suspended solids (TSS – quantity and nature)
- ◆ ammonia (NH_4^+)
- ◆ oxidation by permanganate in an alkaline medium (presence of organic matter).

Searching for the origins of the water is facilitated by:

- ◆ total ionic assessment;
- ◆ BOD5 (biological oxygen demand over 5 days) which represent the quantity of oxygen needed for the micro-organisms to oxidise (break down) all the organic matter in a sample of water maintained at 20°C, in the dark, for 5 days;
- ◆ COD (chemical oxygen demand) which is the consumption of oxygen by strong chemical oxidants to oxidise the organic substances and minerals in the water; it makes it possible to assess the pollutant load;
- ◆ the total nitrogen content (K).

The overall interpretation of the results can be complex. We can provide a few guidelines, in the form of warning thresholds which can indicate the need for more complex investigations.

Water is potentially aggressive if:

- ◆ the pH is less than 6.5;
- ◆ the CO₂ content is about 15 to 30 mg/l;
- ◆ the Langelier index is negative;
- ◆ the Riznar index is greater than 7 (corrosive and even very corrosive if I_R > 8.5);
- ◆ SO₄⁻ content is greater than 200 mg/l;
- ◆ Mg⁺⁺ content is greater than 300 mg/l;
- ◆ NH₄⁺ content is greater than 15 mg/l;
- ◆ TAC is less than or equal to 5°f;
- ◆ Cl⁻ content is greater than 250 mg/l.

Water has the potential for carbonate deposition if:

- ◆ the Langelier index is positive;
- ◆ the Riznar index is less than 6 (very incrusting if IR<5).

The presence of organic matter is proven if:

- ◆ COD is greater than 10 mg/l
- ◆ BOD₅ is greater than 6 mg/l
- ◆ oxidation to permanganate in an alkaline medium is greater than 4 mg/l.

10.6.2 Analysis of the composition of mortars and concrete

It is possible to determine the original composition of mortar or concrete, especially the nature of the binder (lime or cement) by taking measurements or conducting the tests listed below:

- ◆ density,
- ◆ porosity,
- ◆ water content,
- ◆ chemical analysis on the soluble fraction in nitric acid (HNO₃),
- ◆ simultaneous thermogravimetric differential thermal analysis,
- ◆ determination of the mineral species present via X-ray diffractometry,
- ◆ examination under scanning electron microscope.

Some of these tests require highly technical equipment. They also make it possible to detect reactive chemical products (sulphate reaction or alkali reaction). The tests are expensive and interpreting them is complex.

10.6.3 Tests on concrete

In the laboratory, tests on concrete are most often undertaken on core samples obtained from holes drilled on site, taking certain precautions. The following can be mentioned:

- ◆ measuring the depth of carbonation (phenolphthalein test),
- ◆ the chloride concentration profile,
- ◆ measuring the compressive strength.

On site, the surface hardness is measured (sclerometry) primarily for the purposes of information and comparison.

10.6.4 Other in situ tests

The use of hydrochloric acid (HCl) makes it possible, by wetting the material, to differentiate between dolomite from calcareous elements (the latter is effervescent, unlike dolomite), but also to quickly resolve any ambiguity as to the nature of certain concretions.

10.7 Appendix 7: Investigative techniques and additional tests

The list of techniques mentioned below is incomplete. It reflects what is commonly used in the tunnel. Some tests are destructive and should not be undertaken on all structures; dimensional measurements carried out periodically make it possible to show the rates of deformation or displacement and therefore a possibly dangerous acceleration towards instability. Their use assists in three situations:

- ◆ following the change in a structure over time (1)
- ◆ completing a detailed inspection in order to establishing the final diagnosis (2)
- ◆ carrying out the additional investigations as part of a rehabilitation project (3).

The techniques and tests specified, through their titles, indicate the objectives for which they are used.

10.7.1 Crack measuring (1)

This technique is used on one or several isolated cracks where it is thought that the behaviour represents a local change. It is used on masonry or concrete, and very rarely for cracks in rock (at least in the tunnel).

Plastic strain gauges (to glue across the cracks) have a limited lifespan and only measure the opening of the crack.

The metal devices to be rigidly fixed to the structure allow three-dimensional measurements to be taken (in X, Y and Z) over long periods and are more reliable. The measurements are manual (vernier scale) or automatic (data acquisition unit with or without remote transmission) and are always associated with temperature measurements.

Vibrating wire strain gauges with an electronic sensor have a high degree of accuracy (1/100 mm) and are connected to a data acquisition unit.

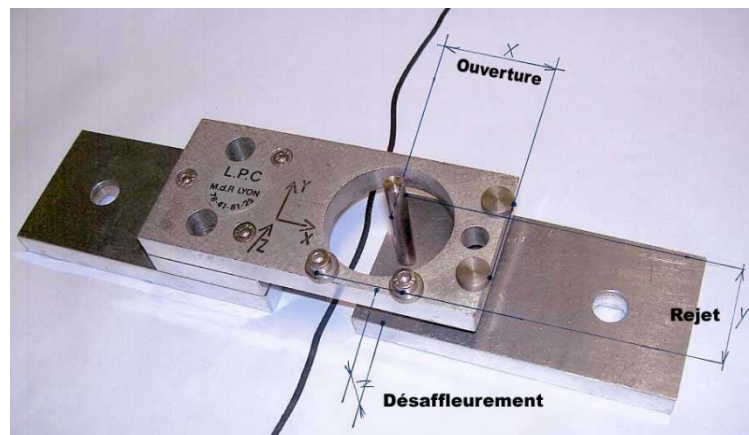

Figure 1: Three-dimensional crack meter (XYZ) to be sealed

10.7.2 Convergence measurements (1, 2, 3)

Convergence measurement consists of determining the variation in distance between reference points fixed to the lining on a section of the structure. In order to know the displacement of the cross-section in space, a 3-dimensional survey of the tunnel must be associated with the convergence measurements. The temperature is also measured in order to be able to interpret the results.

Relative convergences (1, 2)

We speak more precisely of relative convergence because, in most cases, the measurements are not related back to fixed reference points outside the structure, hence the relative nature of the displacements detected.

- **Invar wire distance measurement (LRPC type)**

The measurement device is comprised of invar wires (alloy with about 64% iron and 36% nickel – to which are added chromium, manganese and carbon – and for which the coefficient of expansion is practically zero and sometimes negative) calibrated with a vernier calliper to 1/20 millimetre. The number of reference points installed for each measurement profile varies from 2 to 7. The magnitude and rate deformation of the profile can be deduced from these measurements.

The method can only be undertaken when traffic has been stopped. The lifespan of the reference points (which have to be protected) is several decades, except in the event of traffic impact.

The measurements are taken manually. The accuracy is about 0.2mm, which is enough to monitor the deformations over a long baseline.

- **Electro-Optical distance measurement**

The absence of tensioned wires makes it possible to undertake this technique in low traffic volumes. As with invar wire distance measurement, the number of reference points installed for each measurement profile varies from 2 to 7 and the measurements taken allow the same analyses to be undertaken.

The lifespan of the reference points (which have to be protected) is several decades, except in the event of traffic impact.

The accuracy of this technique is slightly less than that of invar wire measurement but is generally sufficient for current needs.

Absolute convergence (2, 3)

- **Extensometers in cored holes**

The displacement of the lining is measured in relation to a point that is deemed to be stable at the bottom of a borehole (sealed invar bar). The accuracy can be less than 1/10 of a millimetre.

The method is relatively complex (core drilling, delicate seals, cost). It is rarely used for monitoring.

- **Invar wire or electro optical distance measurement associated with topographic survey**

Topographical survey makes it possible to relate back to a stable point outside the tunnel which makes it possible to deduce the absolute movement of the profile in 3-dimensional space.

The accuracy is generally linked to that of the topographical survey.

10.7.3 Levelling (1, 2, 3)

Combined with the measurement of relative convergence by invar wire, levelling provides the displacement of the profile. Beyond a certain length of the structure, accuracy decreases quickly if there are no stable reference points outside of the tunnel. It is very rarely used because of this.

Relative levelling (1, 2, 3)

This provides the displacement of the profile and can be coupled with the measurement of relative convergence by invar wire. A traverse encompassing all of the reference points (on the sidewalls, for example) and based on a benchmark that is considered to be stable provides precision of about 0.2 to 0.5 mm for a traverse of 1 km.

Overall levelling (1, 2, 3)

To complement the above, precision levelling makes it possible to determine variations in height of the original benchmark on which the relative levelling is based. It is based on stable points outside the tunnel (IGN markings in France, for example) and may require rather long traverses (double traverse with operational control).

10.7.4 Measuring the deformation of the lining via extensometry (1)

Extensometers with a short base fixed to the surface of the lining, or incorporated into the lining before concreting, allow its deformation to be measured, i.e. the relative expansion or contraction of the material relative to an initial state. The two types of equipment are vibrating wire extensometers and electric strain gauges for which the resistance varies with their deformation.

From orientation of the device along one of the main deformation axes, assuming elastic behaviour, we can calculate the stress thanks to the elastic modulus of the concrete, which is measured using cores extracted from the lining.

10.7.5 Profilometry via total station or continuously (1, 2, 3)

The measurement of underground profiles is carried out using a laser profilometer, comprised of an electronic theodolite operating without a reflector, mounted on an axis of rotation that is placed parallel to the axis of the tunnel. The frequency of measurement is selected according to the profile read and the degree of accuracy sought. This makes it possible to determine the tunnel profile at any point on the structure.

For each measurement point, the device records the polar coordinates of the point measured in relation to the axis of the profilometer. There is no need to be close to the axis of the tunnel, since the profilometer has a range from 0.30 m to 50 m. The exact positioning of the profilometer in planar coordinates is carried out using a theodolite. The frequency of measurements is selected according to the profile read and the degree of fineness sought. The accuracy of the measurement is ± 10 mm to ± 5 mm. With special precautions, it was possible to achieve an accuracy of ± 3.5 mm during the work on the tunnel under the English Channel.

A hundred or so points per profile is generally enough. This method, which is used systematically for controlling the excavation of tunnels during boring, also makes it possible to verify the geometry of the structure before and during repair work.

On the other hand, it is not suitable for monitoring the change in deformation in tunnels in operation for the following reasons:

- The accuracy of the measurement itself is not sufficient to detect the very small deformation that usually occur in tunnels in service:
- Accurately remeasuring a profile which has been measured previously requires a high degree of precision..

The number of profiles measured per instrument setup, depends on the distance between the profiles which varies from 2 to 10 m, depending on the irregularity of the objects and the precision sought.

Currently, continuous profilometry has become almost standard practice for a repair project. This is often three-dimensional modelling using laser measurements (or lasergrammetry). It is based on the use of laser scanners that can read several million points in three dimensions in just a few minutes. A plot can be obtained every 3 to 5 cm on the intrados of the tunnel and at the edges of the portals. These laser measurements can be combined with digital photogrammetric photographs.

The most common technologies are triangulation (emitting a laser pulse and recording its image by a sensor), measuring transit time (emitting a laser pulse and recording the time of the reflected signal) and measurement via phase difference (emission of a frequency modulated beam via a harmonic wave). According to the method, the device provides ranges varying from a few metres to more than a kilometre, accuracy ranging from one tenth of a millimetre to a few centimetres and acquisition speeds ranging from 500 to more than 100,000 points per second.

The main advantages offered by these methods are the speed in terms of data acquisition and the possibility of taking long-range measurements over areas that are difficult to access.

The major disadvantage with the technology is that the sensors record absolutely everything that is in their path, including objects that are not necessarily of interest for the results: vehicles or people passing nearby, dust, temporary equipment. There must be some filtering of the points measured, which is tedious when the structure has a lot of "noise" or when the dimensions of it require many acquisition stations. Because of this, it is highly recommended to not use the techniques when there is traffic.

10.7.6 Geophysical radar (2, 3)

Electromagnetic wave pulse reflectometry, more commonly known as "geophysical radar", uses very high frequency waves (200 to 1500 MHz). As the emitting and receiving antennae are moved along the measurement profiles (in general the tunnel generators), the reflections of the waves from the various discontinuities encountered form echoes on the radar scans. In particular this method makes it possible to determine the contact interface between the extrados of the lining and the ground if there is no adhesion between the two. Voids and metal objects (ribs, reinforcements) are also detected.

This is a high-output method which allows for a substantial depth of investigation (exceeding 30cm – the investigation depth varies according to the frequency of the waves emitted).

It is difficult to interpret and needs to be calibrated using pre-determined soundings. The presence of water adversely affects the measurements.

It is relatively expensive, not least because this method of investigation cannot be used as a substitute for conventional methods.

10.7.7 Scanning with visible light continuous laser (1, 2, 3)

This technique makes it possible to acquire an image using a **rotating** scanner on board a specialised vehicle. The latter travels along the tunnel at a speed varying between 1.5 and 3 km/h while the rotating scanner sweeps the intrados at high speed in a transverse plane. Some scanners can acquire data over a 360° path (including the carriageway). The raw data acquired is processed by a computer which produces a high-definition image (**maximum** 10,000 pixels per line).

The scanner makes it possible to obtain an image of the entire intrados and to reveal areas that would have been overlooked because of only marginal differences which would not have been identified by conventional systematic logging as there were no deteriorations associated with them. In addition, the scanner image allows a manager to have a complete representation of the actual condition of his tunnel, which manual readings and traditional photographs cannot match.

These images provide very valuable assistance by providing an objective view of an intrados. They are of great interest especially for long and old tunnels for which the intrados is complex and which are poorly characterised by manual readings and which are difficult to appreciate as a whole. As such, if images are acquired periodically, it then becomes possible to estimate the changes much more accurately.

The scanner image can be of great assistance in the case of tunnels that have deteriorations (preselection of areas, scaling dimensions, location of devices, etc.). In the event of a dispute with a company, an objective photographic image, constitutes a valid document, as opposed to a manual survey which can always be contested if it was not counter-checked.

Imaging does not replace an on-site inspection. Some serious deteriorations are invisible on the image, either by their nature (hollow sounding areas, the start of delamination), or because they are lost in the multitude of anomalies that appear. The image does not highlight, among the multitude of objects visible, those that represent a proven, likely or foreseeable problem and require substantial analytical work from the inspector. Finally, the cost is still relatively very high for short structures (less than 1000 m) in light of the fees for making data acquisition equipment available in the field.

It may be useful, in order to spread out these costs, to plan to survey several successive tunnels on a single trip, when this is possible.

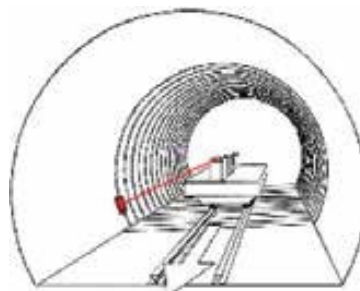
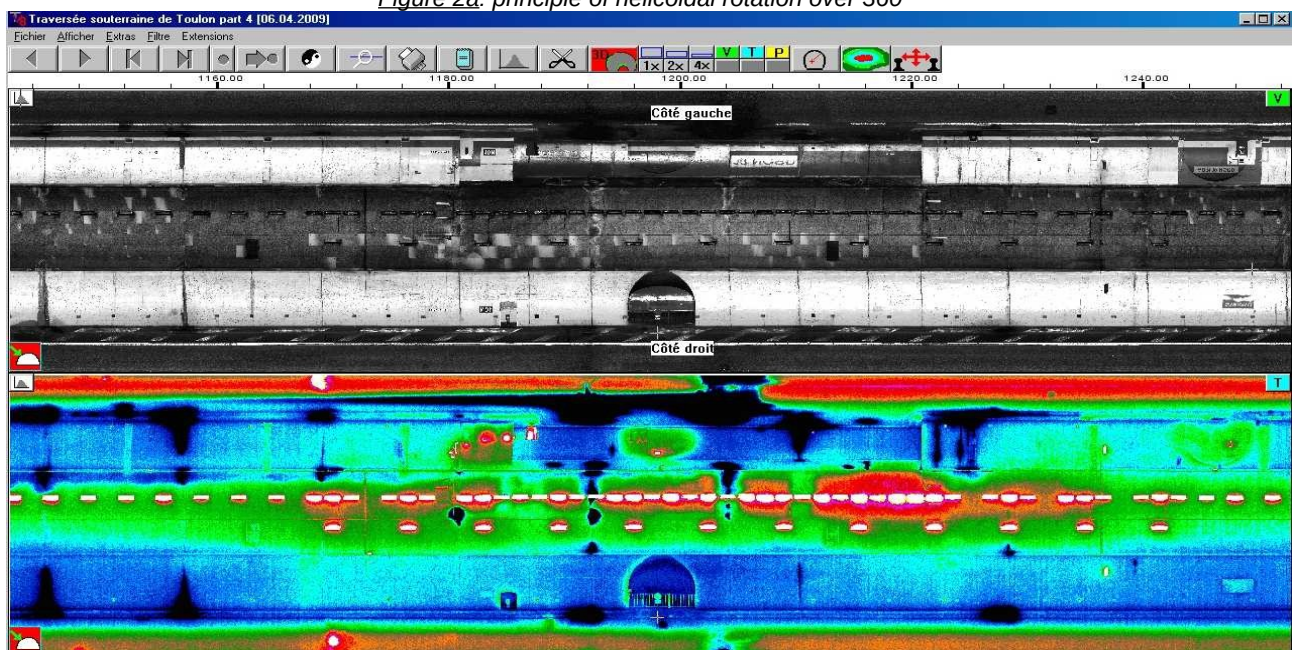

Figure 2a: principle of helicoidal rotation over 360°



Figures 2b and 2c: visible light image scanner and thermography of the same portion of a tunnel

10.7.8 Scanning with continuous laser thermography (1, 2, 3)

The infrared device is a passive or active system. With passive thermography, the scanner records the thermal radiation that is naturally given off by the wall of the tunnel; with active thermography, the scanner emits thermal radiation and measures the reflected thermal radiation from the wall. This method can detect flows of water (or air) located in the lining or at its extrados and, for example, reveal drains concealed by a lining, as long as there is sufficient thermal contrast between the structure and the fluid.

10.7.9 Analyses of mortars and concrete (2, 3)

These are described in **appendix 6**.

10.7.10 Analyses of water (2, 3)

These are described in **appendix 6**.

10.7.11 Pressure measurements (1, 2, 3)

Contact pressure with the ground

Total pressure cells (with vibrating wire or hydraulic pressure sensor), placed between the ground and the lining, make it possible to monitor the changes of the soil-structure interactions during the construction and the initial years of operation.

Hydrostatic pressure

Measuring the hydrostatic pressure from the tunnel is carried out via boreholes in which a, hydraulic, pneumatic or electric pore pressure measuring device is placed (vibrating wire).

10.7.12 Intrusive or core drilling (2, 3)

Normally these techniques are used only in tunnels that are not waterproofed at the extrados.

Short intrusive boreholes (less than 3 m) are generally enough to identify the thickness of the lining, as well as the ground beyond. The attraction of boreholes is their low cost. Their value is in the recording of parameters linked to the advance of the tool (at least: forward speed, thrust on the tool and reflected impact) and with a borehole camera for observation.

Core drilling makes it possible to retrieve intact samples, from the lining as well as from the surrounding ground, for the purposes of laboratory testing (compression tests, physical-chemical or mineralogical characterisation). The cores extracted from the ground must be accompanied by borehole records of joint spacing (for example, the determination of the RQD (rock quality designation) which is the ratio of the sum of the lengths of the elements of cores exceeding 10 cm over the total core length) and colour photographs.

10.7.13 Windows (2, 3)

These are made, especially in old masonry structures built from rubble or bricks, in the lining until contact is made with the ground, as long as there is no waterproofing on the extrados. This method is more difficult to implement in the case of a cast concrete lining and is strongly discouraged when the structure has a comprehensive waterproofing system, on the intrados or on the extrados.

The formation of windows in the lining allows the direct observation of a substantial portion of the lining, its contact with the ground, and a portion of the ground. They also make it possible to be able to take large-size samples.

Precautions must be taken in order to guarantee the stability of the lining and the continuation of the tunnel in operation. In certain cases, it can be necessary to support the arch beforehand with ribs. For this reason, the dimensions of the windows are limited to 0.6 x 0.6 m in the arch. At the sidewall, their height can be increased.

Windows must undergo a systematic survey over all of their surfaces and be photographed.

These are used less and less often, especially due to their high cost (labour costs).

10.7.14 Trenches (2, 3)

They make it possible to determine the nature and the depth of sidewall foundation, the make-up or the deteriorations with a portion of the carriageway.

10.7.15 Mechanical tests on samples (2, 3)

These are generally carried out on cores sampled in the lining or the surrounding ground. The entire range of mechanical laboratory tests can be implemented.

10.7.16 Stress measurements (2, 3)

In situ stress measurements can relate to either the lining or the ground (unlined or by means of a window). There are two major groups of methods.

Method via substitution (flat jack)

Used for measurements on the surface of the intrados or at a shallow depth in the lining, this method consists of substituting the compression stress that one wants to measure with a known external stress.

Method via local release of stresses at the bottom of drilling (overcoring)

This makes it possible to measure the state of the stress inside the rock formation. The principle depends on the measurement of deformations induced in the rock by a local release of the stresses resulting from overcoring.

10.7.17 Other survey techniques

The following types of survey technique are used only in very particular cases in order to answer specific questions:

- ◆ micro-gravity surveys (2, 3)
- ◆ electrical panels (2, 3)
- ◆ microseismic (2, 3)
- ◆ measurement of radioactivity (2, 3)
- ◆ ultrasound (2, 3)
- ◆ dilatometry (2, 3)
- ◆ mechanical impedance (2, 3)
- ◆ permeability tests (2, 3).

10.8 Appendix 8: Principle of sectioning

Note: this appendix includes appendix 4 of the document 40 "Tunnels – Civil engineering works and equipment"

Sectioning makes it possible to view, in summary fashion, similar parts of the civil engineering works of the structure. It consists in dividing the structure into bores and the bores into sections.

10.8.1 Tubes

A tunnel is comprised of one or several bores containing one or several traffic lanes. A bore contains two ends called portals. By convention, a portal has a minimum length of one metre.

A tunnel can also include cross-passages, evacuation galleries and safety galleries; the latter are considered as bores and can also be sectioned.

10.8.2 Sections

A section is a homogeneous length of a tunnel bore in terms of type of structures and geological conditions. It is defined by two metric points (MP) indicating where it begins and ends.

Defined at the time of construction, sections do not vary over time except in exceptional cases, for example, as a result of complex repairs.

10.8.3 Development of the summary document

The development of a summary document is the responsibility of the tunnel manager. This document should be made available before each inspection. An example of a summary document is provided below.

New (or recent) tunnels

The tunnel manager should divide the tunnel into sections. This information should be included in the "as built" file for future interventions on the structure" (in French DIUO).

All of the sections are marked using the final MPs for the structure which should be included in the summary document. It is necessary to provide a precise correlation between MPs used during construction and the final MPs. In order to be able to establish correlations between deteriorations and the structure, the exact limits of each section must be recorded in terms of site monitoring data.

Old tunnels (or tunnels without records)

The summary document should be established using all of the knowledge that has been gathered.

10.8.4 Sectioning – Example

Tronçons		1	2	3	4	5	6	7	8	9	10	11	12	13	14								
GENIE CIVIL	PM des tronçons	-10	-6,5	-5,5	-4,5	-2	26,2	55	66,2	74	85	122,5	130	135	154	196,5	200	230	237	278,5	280,5	284	
	Zone d'influence	1																	1				
	Structure																						
	Calotte	1							2		1			2		1							
	Piédroit droit	1										2		1									
	Piédroit gauche	1								2		1			2		1						
	Extrados tête à l'air libre	1		sans objet																		1	
	Radier	sans objet																					
	Equipements génie civil																						
	Chaussée	sans objet																					
	Drainage	NE																					
	Assainissement	sans objet																					
	Corniche sur tête	1		sans objet																		1	
	Cotation « Génie civil »	1								2		1			2		1						
Tronçons		1	2	3	4	5	6	7	8	9	10	11	12	13	14								
EAU	PM des tronçons	-10	-6,5	-5,5	-4,5	-2	26,2	55	66,2	74	85	122,5	130	135	154	196,5	200	230	237	278,5	280,5	284	
	Structure																						
	Voûte	1								2		1											
	Piédroit droit	1										2		1									
	Piédroit gauche	1								2		1											
	Chaussée	sans objet																					
Cotation « Eau »	1								2		1												

Figure 1: example of sectioning of a tube

10.9 Appendix 9: Marking of a tunnel

Note: this appendix includes appendix 3 of the Booklet 40 "Tunnels – Civil engineering works and equipment"

10.9.1 Purpose of marking

Regardless of the monitoring or operating actions, the observations and remedial work carried out must be accurately located. Marker plates fixed to the intrados of the lining are therefore required. These form "metric points" or MPs.

Marking is required for any intrados survey (roof section, crosspiece and sidewalls) carried out from the ground or from an aerial platform.

A marker spacing of 10 m (decametric marking) must be adopted. It is impossible to quickly locate items when markings that are spaced too far apart.

In recent tunnels, for which the lining is comprised of precast concrete rings, marking can be created using lugs. Nevertheless, it is recommended that decametric marking be adopted.

In tunnels with two parallel bores, each will have its own marking system, but the direction of marking will be the same. When there are ventilation ducts, each duct must be marked in the same way. The metric points for the ducts must coincide with those of the main bore.

For consistency the direction of marking for MPs should be the same as the direction of the PRs for that route..

10.9.2 Origin of the marking

Tunnel entrances are often complex (canopies, architectural portals, etc.) and the actual point of entry into the ground is not always visible. Therefore, the first complete transverse profile should be adopted as MPO.

For monitoring purposes, the actual position of the point of entry to the ground can always be recalculated using construction records, and noted in the survey records. It is important to be cautious and avoid any risk of confusion between the marking system employed during tunnel construction and the marking system set up for tunnel operation.

10.9.3 Permanency of the marking

It is essential for monitoring the structure that the marking system must be:

- **Retained throughout the entire life of the structure**

Detailed inspections reveal numerous indications through using the existing marking. Where the existing marking system is not consistent with the route marking system, or has a zero point which is not very logical, it should nevertheless be retained to ensure continuity in the monitoring over the lifetime of the structure. It must not be modified.

- **Accuracy**

The most accurate method consists of locating MPs on the lining, by calculation referenced to the alignment of the axis of the as built bore.

For short tunnels, a measuring tape (as long as possible) is stretched along the base of a sidewall, making it possible to physically identify the location of the decametric values. This method requires great care, as positioning errors can quickly build up and reach up to 2 to 3% of the total length measured. For long tunnels (over 100 m), the installation of the markers should involve the intervention of a surveyor.

The use of measuring wheels is not recommended as wear and tear leads to substantial cumulative errors. The same applies to topofils.

- **Fixed away from damage by vehicles and vandalism**

A minimum height of 2 m is recommended in order to prevent the risk of vandalism.

- **Legible at distance (a distance of 8 to 10 m), from the ground as well as from an elevated platform**

Numerals should have a height of 8 to 10 cm.

- **Regularly maintained (replacing the plates):**

Periodic cleaning is necessary. If the plates have to be fixed to tunnel fittings that can be replaced (corrugated iron, trimmings, etc.), it is necessary to ensure that they are recovered in order to reinstall them accurately.

10.9.4 Nature of the plates

Stamped aluminium plates similar to car "license" plates should be used for uneven support surfaces such as masonry. Prone to corrosion in certain tunnels, they become increasingly difficult to read with time.



Figure 1: decametric marking (number plate)

Engraved or screen-printed plastic plates are suitable for smooth cladding surfaces, such as cast concrete. They are however brittle and liable to impact damage hence do not withstand deformation very well.



Figure 2: decametric marking (screen-printed plate)

In both cases, retro-reflective plates must not be used as they are incompatible with continuous reading methods (scanner, etc.)

10.9.5 Fastening the plates

There are different methods for fastening:

- ◆ dowels: depending on the support medium, security of fixing is random and the lifespan is rather short;
- ◆ mechanical screws and anchors: this is the best system: it can be adapted to all supports; on sheet metal, parker screws will be used; stainless steel must be used;
- ◆ by use of a quick-setting cement: this method should be avoided (rapidly becomes loose);
- ◆ by gluing with resin (or special adhesives).

10.10 Appendix 10: Frame for annual inspection report

ANNUAL INSPECTION REPORT	Year:
---------------------------------	--------------

Tunnel:	Length:
Bore:	Structure No.:
Lane:	
P.R. :	Operating centre:

Monitoring actions performed in the year:		
	Date	Parties involved
Periodic detailed inspection		
Exceptional detailed inspection		
Summary examination		
Measurements		
Specific visit		
Other		

Summary and assessment of the defects observed or reported (according to the permanent record of events)			
Date	MP	Description	Measures taken

Actions undertaken (safety, maintenance)		
Parties involved	Date	Type

Summary examinations of the portals and approaches
<i>Changes noted on the points for surveillance (PS) of the PDI reports</i>
<i>New facts</i>

Visit of the covering
Compliance of the loads applied (if the covering is weak)
<i>New facts</i>

Summary examinations of the other parts of the structure
<i>Changes noted on the points for surveillance (PS) of the PDI reports</i>
<i>New facts</i>

Actions to plan
<i>For example: request for opinion, visit, inspection, specialised maintenance, etc.</i>

The head of the operational service (date)	The head of the organisational service (date)
(signature)	(signature)

10.11 Appendix 11: Design and codification of the intrados surveys

Adopting a general codification is indispensable for the following reasons:

- ◆ The initial intrados survey is established during the first detailed inspection. Care must be taken to keep it up to date, using the survey reports from subsequent inspections or visits, along with accurate records of the work carried out at specific locations. It is important that these updates can be carried out by technicians other than those who conducted the initial survey, but with the same baseline criteria.
- ◆ It must be possible in future interventions for any purpose, for any relevant person to be able to interpret the survey unambiguously.
- ◆ The survey must clearly show the areas of the structure affecting the safety of the users or of the structure itself.
- ◆ The definition and the application of a coherent policy for the monitoring and maintenance of a set of tunnels will be facilitated through the use of surveys that are fully comparable.

10.11.1 Report of observations

The method used consists of noting the observations on a developed plan of the arch as would be seen from above and "flattened" onto a horizontal plan, in order to obtain a "mapping" of the intrados (figures 25). This type of representation is called "intrados survey".

In the case of a lined tunnel, this survey shows:

- ◆ the main lines of the structure of the lining (joints, particular limits, number of lugs, recesses, etc.),
- ◆ the deteriorations observed, the apparent of the lining or that determined from observations,
- ◆ the interpretation of this state (if possible).

In the case of unlined tunnels (or sections), the survey should resemble a geological survey and should show:

- ◆ discontinuities in the structure of the rock formation, which can lead to instability of blocks of rock,
- ◆ blocks of rock identified as being unstable or potentially unstable.

For certain forms of structures, linings, deteriorations can be codified using figures (hatching, symbols, coloured areas). A few examples are provided below.

10.11.2 The form of the intrados surveys

In the field, observations are rerecorded on millimetre graph paper (or with centimetre squares) which allows for a quick and sufficiently precise survey. For this purpose, decametric marking beforehand of the structure is essential in order to accurately locate objects. A computer graphics tablet can be used in the field in place of paper records.

Regardless of the means used, the accuracy and the quality of the survey should be independent of the system and dependent only on the inspector. In order to facilitate the detailed survey in the field, it is preferable to use the same scale in both the transverse and longitudinal direction.

The intrados survey, to be filed with the inspection report, should be in the form of a linear diagram on which the MPs are marked and of sufficient width to accommodate the developed width of the intrados of the structure. Where a high degree of curvature of the structure makes it necessary for clarity, an alternative representation of the structure can be adopted.

The optimum scale of the drawing is 1/100, in both directions. For large cross-sections and so that the survey remains easy to handle, a scale of 1/200 can be used locally.

10.11.3 Conventions, symbols and figures used in intrados surveys

These must be used with flexibility. In the case of complex or degraded intrados, it is important to favour clarity in the deteriorations affecting the structure (surface area, distribution, induced risk), rather than those affecting the ground or of the lining.

Illustrative and explanatory diagrams

Schéma de levé d'une tête de tunnel revêtu en béton coffré

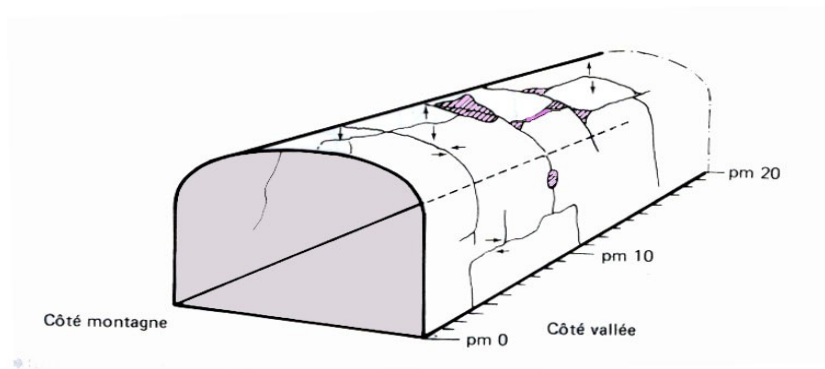
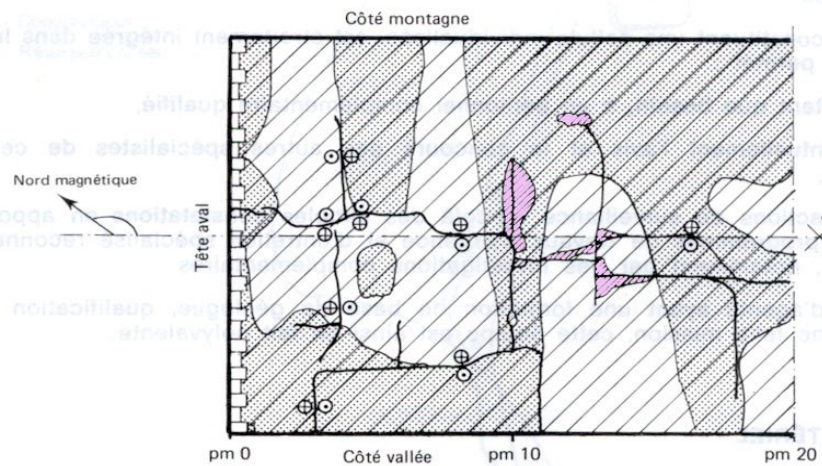

Figures 1a and 1b: Old developed view of the lining and perspective view of a lined tunnel section made of non-reinforced cast concrete

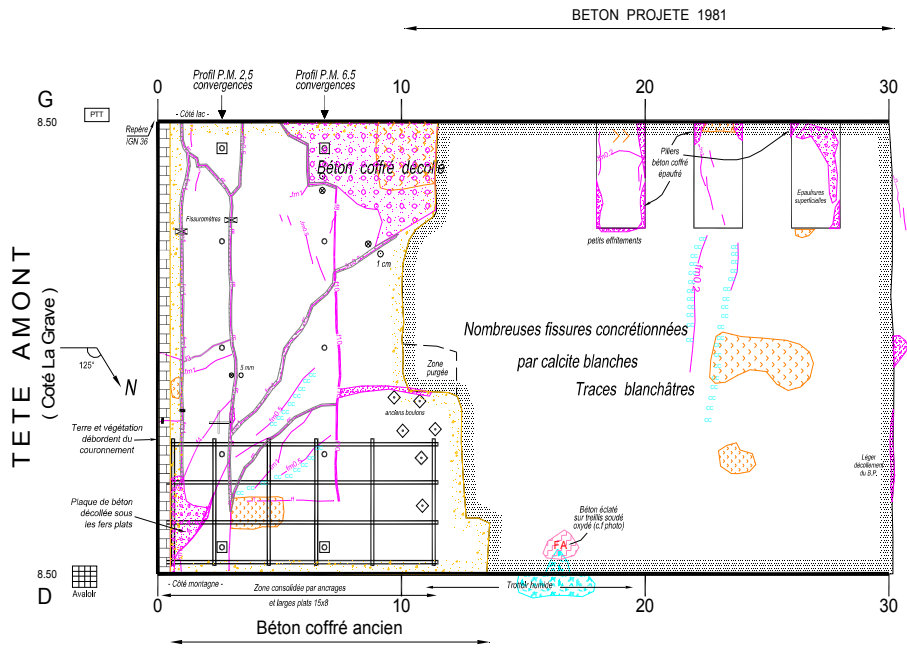

Figure 2c: Recent lining survey (with the RADIS application) with computerised key-entry of the same tunnel [this tunnel benefited from work between the two surveys of deteriorations]

Conventions for geological representations

Some geological symbols have become the de facto standard (conventions for noting faults, characterising cracks, joints) for the representation of information on intrados surveys.

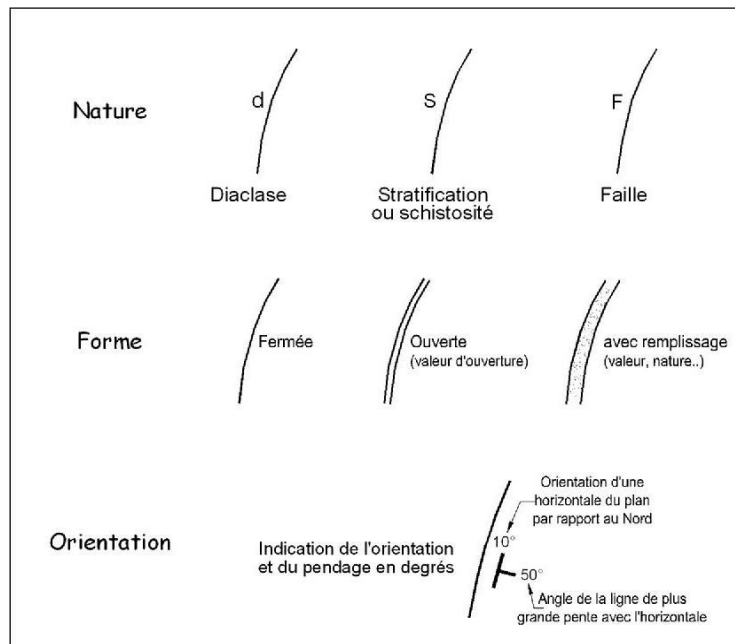

Figure 3a: explanatory drawings of discontinuities

Schéma explicatif du symbole de pendage

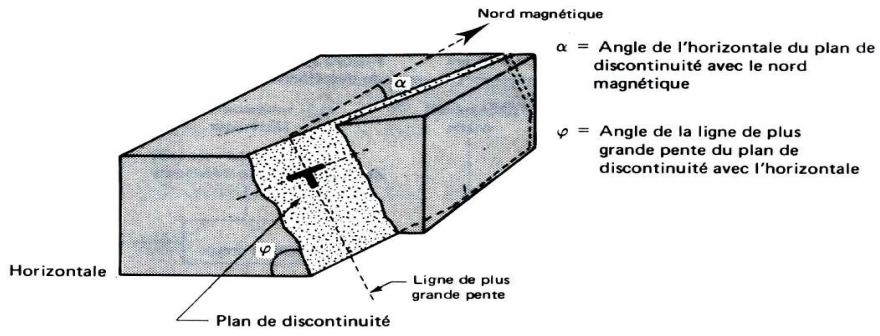
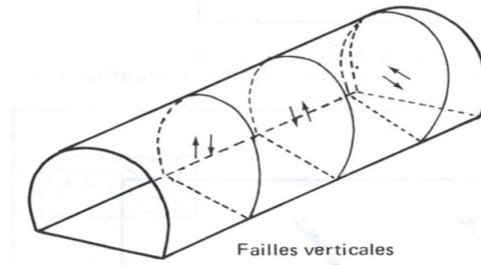

Figure 3b: explanatory drawing of the symbol for faults (orientation)

Exemple de représentation des rejets d'une faille



- Représentation développée -

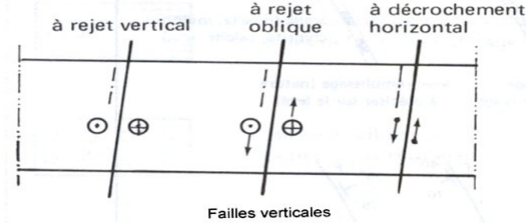

Figure 3c: representations of faults and their displacements

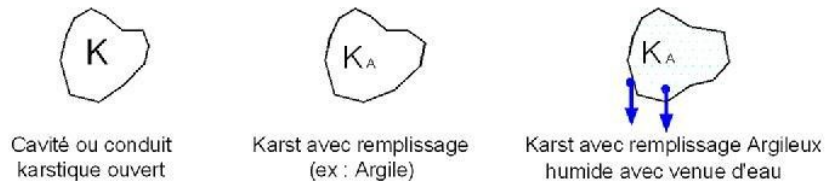
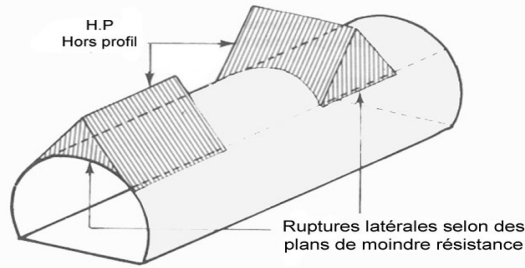

Figure 3d: explanatory drawings of karsts

- Exemple de représentation des hors profils - dans les tunnels non revêtus

----- Représentation dans l'espace -----



----- Représentation développée -----

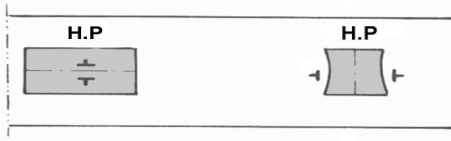

Figure 3e: representations of overbreak in unlined tunnels

Schéma de levé de tunnel non revêtu

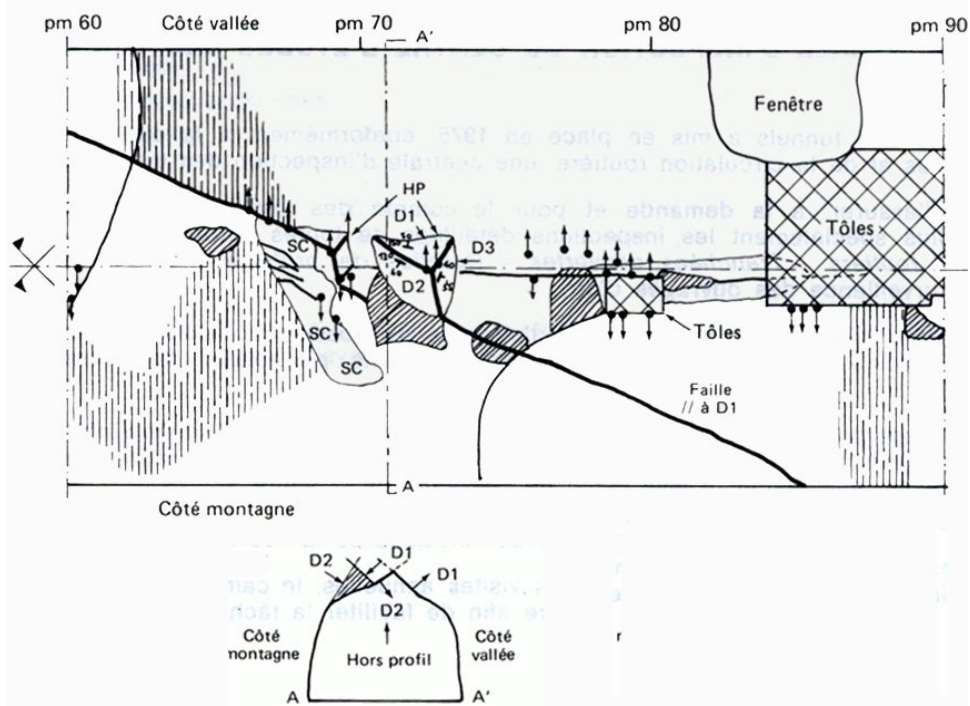

Figure 3f: Example of a representation of a section of unlined tunnel

Conventions for lining and a few pieces of equipment

The examples of figures and symbols provided below form rules for the presentation of data that have been jointly adopted by the CETU and SNCF as well as by all users of the RADIS defect representation software that is marketed by Martinière Plus and SNCF.

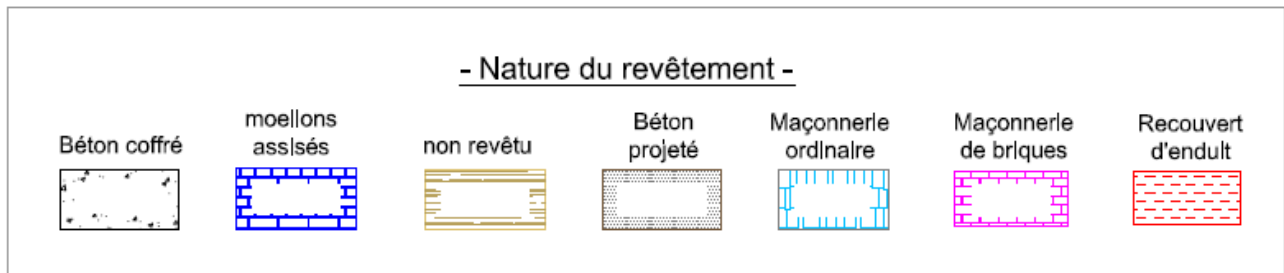

Figure 4a: figures relating to the nature of the lining

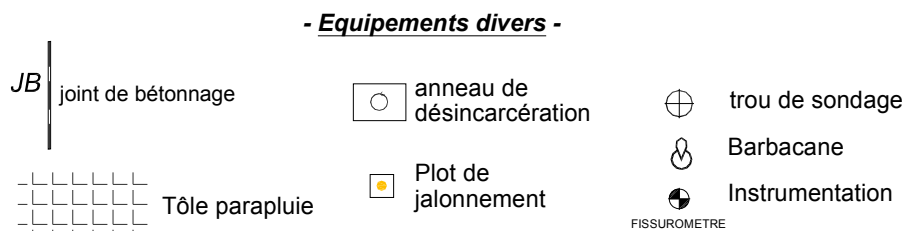

Figure 4b: symbols for various pieces of equipment

Figures and symbols for deteriorations

Although there is some freedom in their number and definition, depending on the specific deteriorations of tunnels, they should be applied consistently across the surveys. The use of colour can make it possible to simplify the figures while improving the legibility of the document.

◆ Cracking

Cracking is a common fault or problem in structures that must be described well. The following two figures illustrate the possible relative displacements of the two sides of a crack, as well as the terms and figures used to quantify it. The values of these displacements (the opening width is the most commonly noted one) are to be measured and noted each time it is possible to do so.

**Schéma explicatif
de la fissuration**

**Conventions de représentation
sur un levé d'intrados**

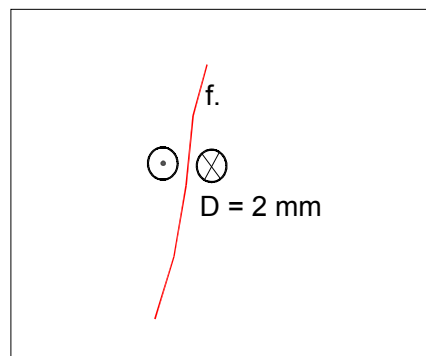
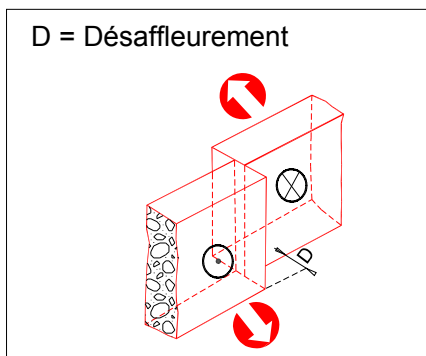
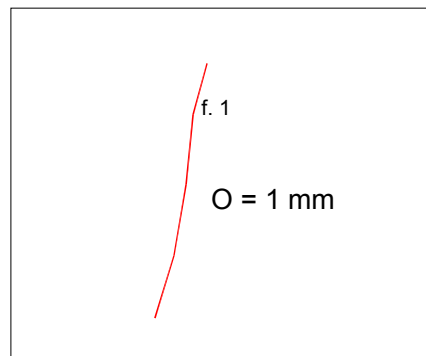
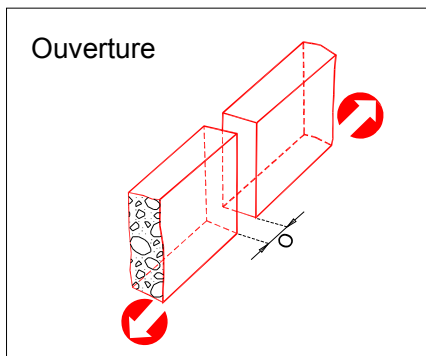

Déplacements relatifs des lèvres de la fissure :

- par rapport à l'observateur

- rapprochement (vers l'observateur)
- ⊗ Eloignement (vers l'extrados)

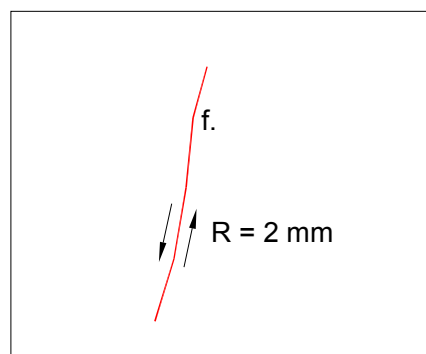
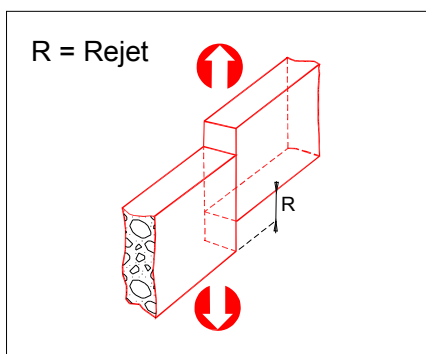

Figure 5a: representation of the movement of a crack

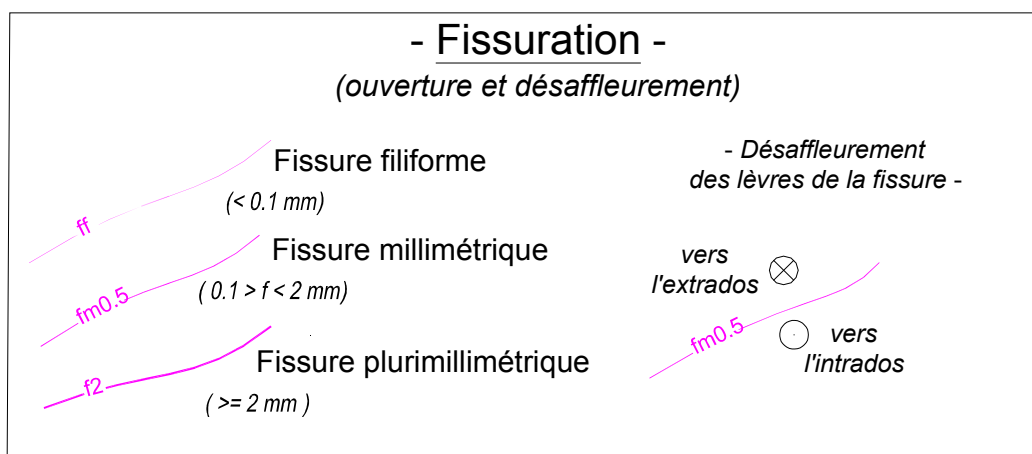

Figure 5b: representation of the crack (RADIS application)

◆ Deteriorations with the lining

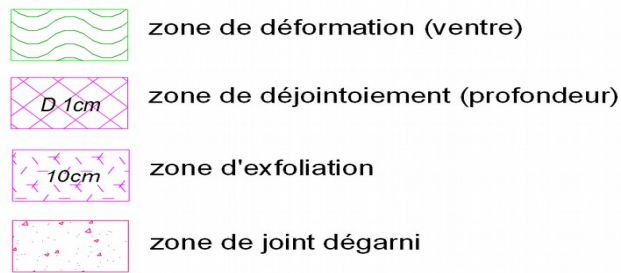

Figure 6a: figures for deteriorations specific to stone masonry

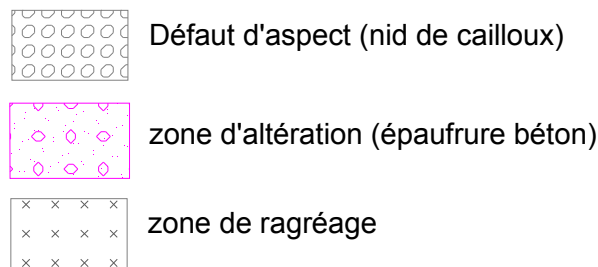

Figure 6b: figures for deteriorations specific to concrete

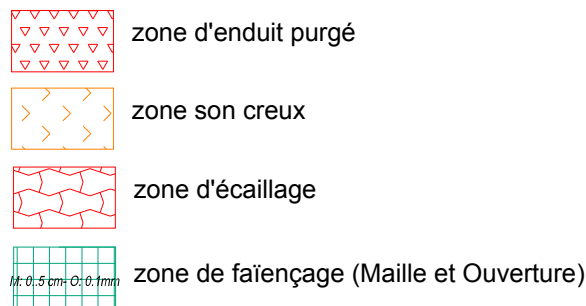

Figure 6c: figures for deteriorations common to all linings

◆ Inflows of water

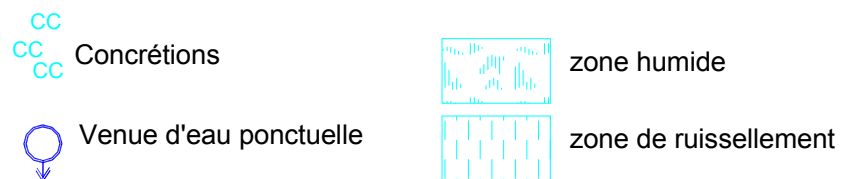

Figure 7: figures for deteriorations specific to water inflow

10.12 Appendix 12: Model for detailed inspection report (DI)

This model applies to periodic detailed inspections. This model can be adapted for the other types of inspection (initial or exceptional), depending on their objectives and the observations to be made, by the tunnel manager.

In any case, the report must include:

- ◆ the name of the requesting service,
- ◆ the names, qualities, levels of speciality and signatures of the inspector or inspectors and of the manager of the service providing organisation.

1 - SUMMARY

Main observations

Main recommendations in terms of maintenance, monitoring and repair work (where applicable).

2 - IDENTIFICATION

Tunnel manager:

Name of the structure:

bore:

Lane concerned (*type of lane, lane number*):

PR of the origin portal:

County:

Town:

Identifier of the structure:

Surface features and contracting party:

Adjacent lanes and contracting party:

Lanes carried and crossed and contracting party:

Disclaimer: the following four paragraphs form a summary of the complete data that can be found on a data sheet of the structure file. This summary is intended to facilitate the understanding of the DI report for a reader who would not have access to the data sheet. It should be established at the first inspection and then updated on a regular basis.

3 – GENERAL CHARACTERISTICS

Summary of the main characteristics of each bore (*number of bores, usable length and width of each bore, distance between sidewalls, etc.*)

Structure of the structure (*false portal, cut-and-cover tunnel, lining, support structure, etc.*), defined per bore, where applicable

Geometry (*arch, frame...*) defined per bore and section, where applicable

Boring methods

Drainage and waterproofing

Sewerage

Road deck and carriageway

Noteable features

Related structures (*underground and exterior*)

Surveillance systems installed (*nature, location*)

Utility networks passing through the structure (*electricity, telecommunication, drinking water, sewerage...*)

Nearby structures (*nature, distance, contracting party, administrative regime*)

Major repairs or improvements

4 – GEOLOGICAL AND GEOTECHNICAL CONTEXT

Geological hydrogeological environment (*general nature of the surrounding ground, any cross-sections, DS25 extracts (evolute for synthetic arch over 25 metres establishing at the time of boring...)*).

Reminder of the particular geological features that required the initial contract to be adapted, or which caused difficulties during construction.

Reminder of the instrumented areas, results.

5 – DESIGN & EXECUTION

Project ownership for studies and work:

Project management for studies and work:

Company or group that holds the building contract and subcontracting companies:

Dates of construction (*start and end of the works*):

Date commissioned:

6 – LIFE OF THE STRUCTURE

Reference documents (*dates of the previous detailed inspections and references of the files, date at the last IQOA evaluation and reference of the file, brief summary of conclusions of prior inspections or visits*)

Maintenance and repair work carried out since the last DI (*routine maintenance, specialised maintenance, repairs, assessment of the work*)

Deteriorations revealed by continuous monitoring

Development work carried out (*dates and nature of major repairs or improvements*)

Specific investigations or monitoring implemented (*measurements, results and analyses*)

Monitoring regime adopted (*reinforced monitoring or intensive surveillance*)

Special safety measures

7 – SECTIONING

Definition of the homogeneous sections marked in MP

8 – CONDITIONS FOR EXECUTING THE DETAILED INSPECTION

Reason and peculiarities of the inspection

Dates, duration

Means implemented (*equipment, specific vehicle, traffic restrictions, complete closure, safety personnel, etc.*)

Precise definition of the parts concerned (or not) by the DI

Weather conditions

9 – OBSERVATIONS

Observations concerning the access, immediate vicinity of the portals, the overlying ground (*portal structure deteriorations linked to ageing or to outside influences, modifications of the nearby environment detrimental to the safety of the users or to the lifespan of certain parts of the tunnel, risks to nearby residents due to the extent of the tunnel*).

The deteriorations and other major facts detected during the inspection can be illustrated in the body of the report, in parallel with the observations.

Observations concerning the intrados of the tunnel (description and analysis of the deteriorations recognised and noted on the intrados surveys (Appendix A)):

- ◆ Masonry:
 - ◆ *description of the devices, the state of the rubble, of the mortars,*
 - ◆ *description of inflows of water*
 - ◆ *state of old repairs,*
 - ◆ *deformation, sagging, cracking, hollow sounding areas;*
- ◆ Concrete:
 - ◆ *description of the general appearance,*
 - ◆ *description of joints,*
 - ◆ *description of cracking (shrinkage, rupture...), hollow sounding areas, inflows of water, various deteriorations;*
- ◆ Unlined:
 - ◆ *exact location and description of the unstable or potentially unstable rock formations (nature, volume);*
- ◆ *inflows of water.*

Observations concerning the systems for drainage, waterproofing and purification (description, deteriorations, state of congestion);

Observations concerning the carriageways and the hard shoulders (description, deteriorations);

Observations concerning the structures or related features:

Note 1: Depending on the configuration of the tunnel, this is discussed by area or by nature of the problem.

Note 2: Same approach should be adopted for all of related structures that fall within the scope of the DI (galleries, ducts, shelters or technical recesses, shafts, etc.).

Note 3: Based on these observations, points for surveillance (PS) during the annual inspections must be selected, which from then on have to be reported on the surveys. They should be illustrated with photographs, wherever possible.

10 – INVESTIGATIONS, MEASUREMENTS, TESTS

Use of additional investigations, tests and measurements (reason, nature, description and analysis of the results) carried out since the last inspection.

Recommendations for new investigations, where applicable.

11 – SUMMARY NOTE

Conclusions of the DI:

- ◆ Changes in relation to previous inspections
- ◆ Summary and interpretation of the measurements, investigations, tests

Follow-up to be given:

- ◆ Proposals for safety measures if necessary, for a modification of the monitoring regime (modification of the frequency, intensity of monitoring regime, etc.)
- ◆ Reminder of any additional investigations recommended
- ◆ Recommendations concerning routine and specialised maintenance
- ◆ Proposals concerning repairs to be scheduled (degree of urgency, type of action).
- ◆ Recommendations for the annual inspections – List of points for surveillance (PS)
- ◆ Proposals for setting up or modifying the monitoring regime (modification of the frequency, more intensive monitoring or monitoring frequency, etc.)

Points that threaten the immediate safety of users (and/or of the structures) are to be clearly defined and marked. The head of the operational service must be informed as soon as they have been observed (or as soon as possible after the onsite inspection) via email or fax.

12 – PROPOSAL OF AN IQOA RATING

Reminder of the rating classes

Civil engineering:

- ◆ Rating of the state of the civil engineering works by sub-parts and summary by parts,
- ◆ Breakdown into areas,
- ◆ Summary of the scores.

Presence of water:

- ◆ Rating by sub-parts and summary by parts.
- ◆ Breakdown into areas
- ◆ Summary of the scores.

13 – APPENDICES

Appendix A: Report for the intrados surveys (one survey per bore inspected)

Appendix B: File for the illustrations

- Structural details arising from the deteriorations (extracts of the structure file, or plans created specially),
- Graphs, bar graphs, drawings explaining the observation.

Additional appendices (according to need: tests, measurements, sounding cross-sections, etc.).

10.13 Appendix 13: Example of an IQOA rating for a tunnel

10.13.1 Stage 1: Establishing the sectioning – Example

Points métriques	-10	-5,5	-2	26,2	55	66,2	74	85	122,5	130	135	154	196,5	200	230	237	284
géométrie	profil voûté																
structure	tête	tunnel creusé														tête	
géologie		calcaire micritique			calcaire gris beige bioclastique						calcaire oolithique		marnes				
soutènement	sans	P3	P2	P3	P2	P1	P3	P2	P1	P3	sans						
étanchement	feuille PVC																
revêtement	Béton Armé	béton non armé														béton armé	
Tronçons	1	2	3	4	5	6	7	8	9	10	11	12	13	14			

Figure 1: example of sectioning of a tube

10.13.2 Stage 2: Distribution of the sections – Example

Tronçons		1	2	3	4	5	6	7	8	9	10	11	12	13	14							
GENIE CIVIL	PM des tronçons	-10	-6,5	-5,5	-4,5	-2	26,2	55	66,2	74	85	122,5	130	135	154	196,5	200	230	237	278,5	280,5	284
	Zone d'influence																					
	Structure																					
	Calotte																					
	Piédroit droit																					
	Piédroit gauche																					
	Extrados tête à l'air libre																					
	Radier																					
	Equipements génie civil																					
	Chaussée																					
	Drainage																					
	Assainissement																					
	Corniche sur tête																					

	EAU	Tronçons	1	2	3	4	5	6	7	8	9	10	11	12	13	14						
PM des tronçons		-10	-6,5	-5,5	-4,5	-2	26,2	55	66,2	74	85	122,5	130	135	154	196,5	200	230	237	278,5	280,5	284
Structure																						
Voûte																						
Chaussée																						

Figure 2: example of the distribution of the sections of a tube

10.13.3 Stage 3: Detailed inspection (see chapter 6)

10.13.4 Stage 4 (optional): Summary of the deteriorations – Example

Tronçons		1	2	3	4	5	6	7	8	9	10	11	12	13	14								
GENIE CIVIL	PM des tronçons	-10	-6,5	-5,5	-4,5	-2	26,2	55	66,2	74	85	122,5	130	135	154	196,5	200	230	237	278,5	280,5	284	
	Zone d'influence			Béton projeté décollé																			
	Structure																						
	Calotte		Fer apparent										Fissure longitudinale								Fissures transversales		Nid de cailloux
	Piédroit droit																				Fissures transversales		
	Piédroit gauche													Fissures en lunule							Fissures transversales		
	Extrados tête à l'air libre	sans objet																					
	Radier	sans objet																					
	Equipements génie civil																						
	Chaussée	sans objet																					
	Drainage	Réseau engorgé																					
	Assainissement	sans objet																					
	Corniche sur tête	sans objet																					
	EAU	Tronçons	1	2	3	4	5	6	7	8	9	10	11	12	13	14							
PM des tronçons		-10	-6,5	-5,5	-4,5	-2	26,2	55	66,2	74	85	122,5	130	135	154	196,5	200	230	237	278,5	280,5	284	
Structure																							
Voûte													Goutte-à-goutte										
Piédroit droit																							
Piédroit gauche													Goutte-à-goutte										

Figure 3: example of a summary of the deteriorations in a tube

10.13.5 Stage 5: Rating of the sub-parts and of the parts – First and second aggregation of the IQOA scores

Tronçons		1		2		3		4		5		6		7		8		9		10		11		12		13		14			
PM des tronçons		-10	-6,5	-5,5	-4,5	-2	26,2	55	66,2	74	85	122,5	130	135	154	196,5	200	230	237	278,5	280,5	284									
GENIE CIVIL	Zone d'influence	1																													
	Structure																														
	Calotte	1								2		1				2		1													
	Piédroit droit	1												2				1													
	Piédroit gauche	1								2		1				2		1													
	Extrados tête à l'air libre	1		sans objet														1													
	Radier	sans objet																													
	Equipements génie civil																														
	Chaussée	sans objet																													
	Drainage	1																													
	Assainissement	sans objet																													
	Corniche sur tête	1		sans objet														1													
	Cotation « Génie civil »	1								2		1				2		1													

Tronçons		1		2		3		4		5		6		7		8		9		10		11		12		13		14			
PM des tronçons		-10	-6,5	-5,5	-4,5	-2	26,2	55	66,2	74	85	122,5	130	135	154	196,5	200	230	237	278,5	280,5	284									
EAU	Structure																														
	Voûte	1								2		1																			
	Piédroit droit	1																													
	Piédroit gauche	1								2		1																			
	Chaussée	sans objet																													
Cotation « Eau »	1								2		1																				

Figure 4: example of an IQOA-Tunnels "Civil engineering" and "Water" rating

10.13.6 Stage 6: Summary of the IQOA scores

Cotation Génie Civil				
PM début	PM fin	Long	Note	S
-10	122,5	132,5	1	
122,5	135	12,5	2	
135	230	95	1	
230	237	7	2	
237	284	47	1	

Cotation Eau				
PM début	PM fin	Long	Note	S
-10	130	140	1	
130	135	5	2	
135	284	149	1	

Tube	Cotation Génie Civil							Cotation Eau				
	1	2	2E	3	3U	NE	S	1	2	3	NE	S
Tube nord (m)	274,5	19,5	0	0	0	0	0	289	5	0	0	0
Tube nord (%)	93%	7%	0%	0%	0%	0%	0%	98%	2%	0%	0%	0%

Tube	Cotation Génie Civil							Cotation Eau				
	1	2	2E	3	3U	NE	S	1	2	3	NE	S
Tube nord (m)	274,5	19,5	0	0	0	0	0	289	5	0	0	0
Tube nord (%)	93%	7%	0%	0%	0%	0%	0%	98%	2%	0%	0%	0%
Tube sud (m)	276	15	0	0	0	0	0	291	0	0	0	0
Tube sud (%)	95%	5%	0%	0%	0%	0%	0%	100%	0%	0%	0%	0%
Tubes nord et sud (m)	550,5	34,5	0	0	0	0	0	580	5	0	0	0
Tubes nord et sud (%)	94%	6%	0%	0%	0%	0%	0%	99%	1%	0%	0%	0%

Figure 5: example of an aggregation of IQOA-Tunnels ratings

10.14 Appendix 14: Nature and rating of the deteriorations – Area of influence

Observable defects	Possible origins	Condition class
Overall stability		
Cracking or fracturing of the ground at portal	- Nature of the surrounding rock mass - Overall movement of the rock mass	1 to 3U
Local collapse	- Nature of the surrounding rock mass - Consequences of climate phenomena	2 to 3
Ground surface deformations (in the form of waves)	- General movement, revealing an overall sliding of the rock mass	2E or 3U
Surface erosion, gully formation		1 to 2E
Abnormal inclinations of trees or poles	- General movement, revealing an overall sliding of the rock mass	1 to 3U
Modifications of the environment		
Presence of unforeseen structural overload		1 to 2E
Accumulation of materials		1 to 2
Recent construction in the area of influence		Not scored
Presence of harmful vegetation		1 to 2E
Faults with utility networks at the structure portal		Not scored

10.15 Appendix 15: Nature and rating of the deteriorations – Civil engineering equipment

Observable defects	Possible origins	State class
Ventilation slab and partition		
General or localised mis-alignment, at base level or at height Alteration of material properties Malfunction of hangers Faults with joints between elements Faults with support devices Cracks	- Poor workmanship during construction - Impact - Physical-chemical actions of the surrounding environment	1 to 2E
Carriageway		
Longitudinal and transverse cracks	- Fatigue of the upper pavement layer - Poor execution of construction joints	1 or 2
Crazing	- Excessive fatigue of the upper pavement layer - Poor behaviour of the carriageway materials	1 or 2
Potholes	- Poor material quality at time of batching - adhesion fault	1 or 2
Surface faults (small depressions, delamination, rutting, waves, upflow of water)	- Poor behaviour of the carriageway materials - Poor workmanship	1 or 2
Settlement	- Degradation of the foundation layers - Creep of the carriageway Differential settlement	2E
Walkway and kerblines		
Faults with carriageway edges - general or localised misalignment - loss of one or more kerb elements - degradation of of kerb elements (open jointing, spalling, crumbling)	- Poor workmanship - Impact - Physical-chemical actions of the surrounding environment	1 or 2
Surface faults with walkways - degradation of the surfacing - surface deformation - presence of vegetation	- standing or ponding water - Poor material behaviour - Insufficient maintenance	1 or 2
Settlement of the walkway	- Cracking of paving slabs - Poor workmanship - Poor material behaviour - Vehicle traffic - Water infiltration	1 or 2

Observable defects	Possible origins	State class
Retaining devices – Devices for fastening operating and safety equipment		
General or local misalignment, at the base or at height Alteration of constituent materials deterioration of the paint or of the galvanising Alteration of the fasteners	- Poor workmanship - Impact - Physical-chemical actions of the surrounding environment	1 or 2
Architectural elements and features		
General or localised misalignment, at the base or at height Alteration of constituent materials Alteration of the fasteners Faults with joints between prefabricated elements	- Poor workmanship - Impact - Physical-chemical actions of the surrounding environment	2
Control and removal of water		
Blockage	- Maintenance fault	1 to 2E
Ponding of water	- Absence of drainage for removing water - Poor drainage design - Construction fault - Degradation of the drainage system devices through wear and tear, accidents or vandalism	1 to 2E
Water seepage on the intrados	- Failure of drainage system - Waterproofing fault	2 or 2E
General Degradation	- Wear and tear, vandalism, maintenance fault or accident	1 to 2E
Waterproofing and joints		
Water penetration through waterproofing Seepage Inflow leakage		2 or 2E

AUTHORS

C. BOULOGNE, S. FRACHON, J. KASPERSKI, C. LARIVE, Y. PERU, A. ROBERT, V. ROBERT, F. SPATARO, D. SUBRIN

Thanks to Donald LAMONT and Kristen DROUARD for the english translation



Centre d'Études des Tunnels

25, avenue François Mitterrand
Case no. 1
69674 BRON – FRANCE
Tel. 33 (0)4 72 14 34 00
Fax. 33 (0)4 72 14 34 30
cetu@developpement-durable.gouv.fr

